

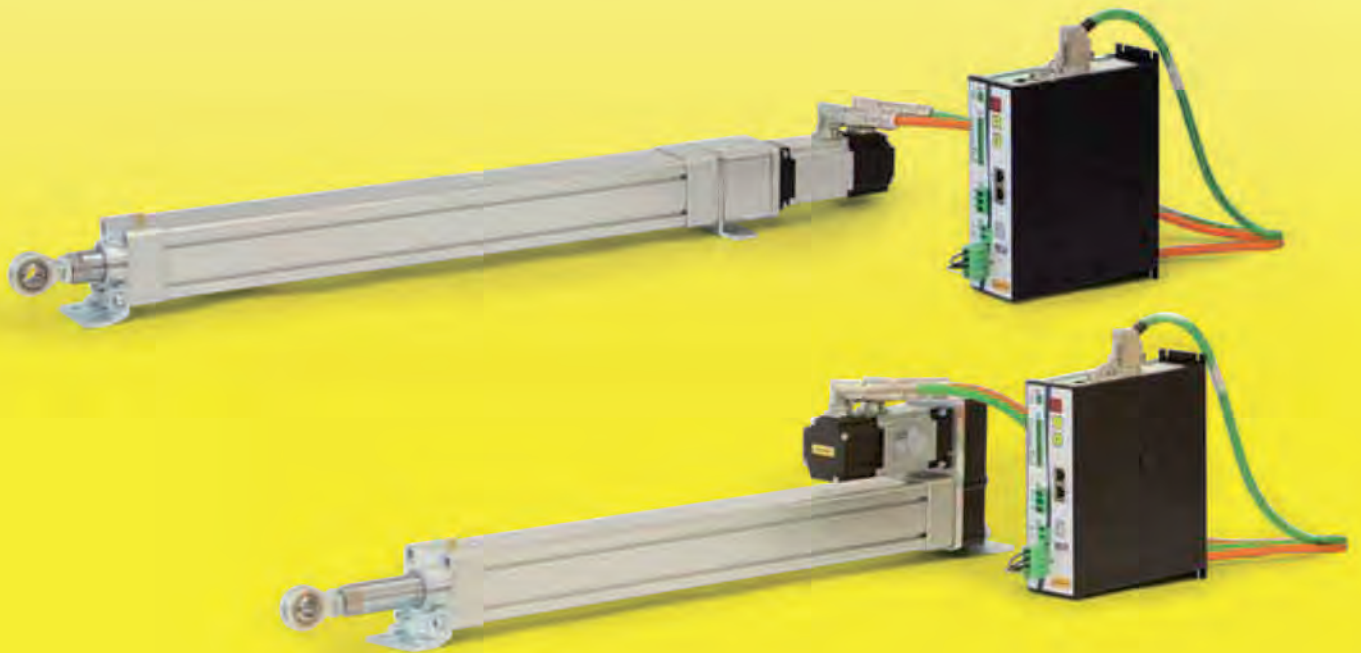

Linear Servoactuators

Actuators + Brushless Servomotors + Drives



Catalogue 01 / 15

© Copyright LINEARMECH 2015

Every care has been taken to ensure the accuracy of the contents contained in this catalogue, anyway such information are given as indication only and no liability can be taken for any error or omission. LINEARMECH reserves the right to modify the contents at his own discretion at any time and without notice.

Summary

1. SERVOMECH Group	page 2	7. Ball screw sizing	62
2. LINEARMECH Servoactuators	4	7.1 Lifetime calculation	62
2.1 General features	4	7.2 Ball screw lifetime	64
2.2 Construction features	6	7.2.1 Size 0 Servoactuator	64
2.3 Ball screws and nuts	8	7.2.2 Size 1 Servoactuator	65
2.4 Construction technology	9	7.2.3 Size 2 Servoactuator	66
3. SA Series Actuators	10	7.2.4 Size 3 Servoactuator	67
3.1 Technical data	10	7.2.5 Size 4 Servoactuator	69
3.2 Dimensions	12	7.2.6 Size 5 Servoactuator	70
3.3 Performances	13	7.2.7 Size 6 Servoactuator	72
3.3.1 SA 0	13	7.3 Buckling resistance	74
3.3.2 SA 1	13	7.4 Critical speed	77
3.3.3 SA 2	14	8. Positioning accuracy	81
3.3.4 SA 3	15	9. Lubrication	83
3.3.5 SA 4	16	10. Limit switches	84
3.3.6 SA 5	17	10.1 Technical data	85
3.3.7 SA 6	18	11. BM Series Brushless Servomotors	86
4. SA IL Series Servoactuators	20	11.1 General data	86
4.1 Technical data	20	11.2 Construction technology	87
4.2 Dimensions	22	11.3 Technical data	88
4.3 Accessories dimensions	24	11.4 Motor feedback	92
4.4 Performances	26	11.5 Thermal protectors	93
4.4.1 SA 0 IL	26	11.6 Motor connections	94
4.4.2 SA 1 IL	27	12. ECO Series Drives	97
4.4.3 SA 2 IL	28	12.1 General features	97
4.4.4 SA 3 IL	29	12.2 SAP (Stand Alone Positioning)	98
4.4.5 SA 4 IL	30	12.3 MSQ (Movement Sequencing Controller)	99
4.4.6 SA 5 IL	31	12.4 Electrical axis	100
4.4.7 SA 6 IL	33	12.5 Field networks	100
5. SA PD Series Servoactuators	36	12.6 Models and functions	101
5.1 Technical data	36	12.7 Available transducers	101
5.2 Dimensions	38	12.8 Recommended servomotor-drive matching	102
5.3 Accessories dimensions	40	12.9 Dimensions	104
5.4 Performances	42	13. Connecting cables	105
5.4.1 SA 0 PD	42	13.1 Power supply cable	105
5.4.2 SA 1 PD	43	13.2 Signal cable	105
5.4.3 SA 2 PD	44	14. Ordering code	106
5.4.4 SA 3 PD	45	14.1 SA Series Actuators	106
5.4.5 SA 4 PD	47	14.2 SA IL Series Servoactuators	106
5.4.6 SA 5 PD	49	14.3 SA PD Series Servoactuators	106
5.4.7 SA 6 PD	52	14.4 BM Series Servomotors	107
6. Drive sizing	58	14.5 ECO Series Drives	108
6.1 Required motor torque	59	14.6 Connecting cables	109
6.2 Thermal verification of the servomotor	60		
6.3 Drive selection	61		

Our choice: internal production of all components

SERVOMECH manufactures **electric linear actuators** and **mechanical screw jacks** since 1989.

From the raw material to the finished product, the complete production process to manufacture our linear actuators and screw jacks is entirely carried out in our factory in Bologna, with CNC tool-machines updated to the newest manufacturing technologies.

- **Vertical integrated production** and totally **customized solutions** to your specific application needs.
- **Statistical quality controls** during all the production processes to manufacture reliable products with constant quality over the time.
- **Certified quality** of the raw material: selected and certified Italian suppliers have been our partners for many years. Additional checks are regularly carried out by our check-in inspection service, assuring the quality of our raw materials.
- **Competitive solutions** also in price, thanks to the internal production of all the components and the absence of intermediaries.



LINEARMECH: Automation inside SERVOMECH Group

Mechanical skills and specific know-how of the parent company Servomech, 25+ years of worth experience on the field of linear motion, finally merge into a new generation of **servoactuators, brushless servomotors and drives** made by LINEARMECH.

LINEARMECH is a company of SERVOMECH Group. The head offices of the group are located in Anzola dell'Emilia, Italy, near Bologna airport "Guglielmo Marconi" and the highway A1 (exit Borgo Panigale).

Linear Servo Systems



Linear Actuator + Brushless Servomotor + Drive = Full Integration

A successful application is the result of many different elements. The selection of the right components is only a part of the job. The interaction of the various components to each other must be carefully evaluated, since linear motion mechanical component (servoactuator), electric unit (servomotor) and drive system have to work together. The integration among these components is definitely hard to achieve, due to the big efforts and increasing costs that the necessary intellectual skills ask for.

LINEARMECH offers a **totally integrated solution** thanks to:

Experience Our 25+ years consolidated experience in linear motion industry leads us to offer the market a brand new product, thanks to the specific know-how gained on the field.

Innovation That's the leading element of the new LINEARMECH servoactuator engineering and design. This project has nothing to do with linear actuators with acme or ball screw drive currently available on the market. All the internal components have been redesigned to reach a higher level of efficiency and performances. LINEARMECH servoactuators, as real innovative products, stand out from competitors and allow the positioning in **high quality automation components range**.

Production Our strenghts: servoactuators, brushless servomotors, ball screws and nuts are completely designed and manufactured in our factory in Anzola dell'Emilia (Bologna, Italy).

Flexibility Thanks to the internal design and production of all components, we are able to support you with customized solutions. For instance, we offer servoactuators that easily fit other suppliers servomotors. Customers can choose freely which components better meet their needs.

Integration Native integration of all components means they are designed and optimized to work together to reach the **highest performances** focusing on Automation Industry and linear motion. This is our **secret ingredient** to let you save your money and your time.

LINEARMECH Servoactuators are electromechanical cylinders, designed and manufactured to lead **real innovation** in the Automation Industry.

SERVOMECH Group is the main supporter of this project, thanks to 25+ years experience and know-how in electromechanical acme and ball screw actuators production for the Automation and Industrial application in general.

The **new range of servoactuators SA Series** by LINEARMECH is produced with new solutions, completely different from those of the traditional electromechanical actuators. All internal components have been re-designed and developed in order to improve the performances in terms of high speed, low inertia, high accuracy and repeatability in positioning, reliability and lifetime.

The strongly innovative elements of LINEARMECH servoactuators make them stand out from competitors and allow the positioning in **high quality automation components range**.

By comparing the traditional pneumatic and hydraulic cylinders with LINEARMECH new range of servoactuators you will find immediate advantage:

- Higher energy efficiency
- Low environmental impact
- Excellent speed control, from speed close to zero up to the max. permissible speed
- Excellent positioning control in any stroke position, intermediate or extreme
- Excellent load control, within a wide range of values.

The mechanical construction of LINEARMECH servoactuators, in compliance with **ISO 15552 standards** for cylinders, allows the mounting of different standard types of fixing elements, simplifying the application and the final assembling. It is also easy to replace the traditional pneumatic cylinders with LINEARMECH electromechanical servoactuators, because the fixing attachments are the same in type and dimensions.

There are several different application fields, most of all looking for the highest level of **automation, productivity, efficiency and reliability**.

2.1 General features

- 3 different models, with the same linear drive unit:
 - SA Series** Actuator easy to fit customers motors;
 - SA IL Series** Servoactuator fitting brushless servomotor - *In-Line Design*: motor connection with bell housing and torsionally rigid coupling for a better control and improved level of motion accuracy
 - SA PD Series** Servoactuator fitting brushless servomotor - *Parallel Design*: motor connection to the ball screw with precision timing belt and direct fitting of the pulleys on the shafts for a better control and improved level of motion accuracy
- 7 different sizes to cover a wide range of performance
- Rolled ball screws, accuracy grade IT 7, with integrated lubrication sealing system for the nut (lubricant reserve and seals, specifically designed for Linearmech servoactuators high performances range). Available on request solutions with preloaded nuts
- Ball screws with accuracy grade IT 5 available on request
- Robust and compact design
- Wide choice of fixing attachments in compliance with ISO 15552 standards

SA Series Actuator

Input shaft version, **easy to fit customer servomotors**.

Available in two versions:

Vers. 1: cylindrical input shaft (standard);

executions in different sizes with or without key available on request

Vers. 5: specific coupling to fit motors / gear motors

supplied by customer (on request)



SA IL Series Servoactuator

“**In Line Design**” execution, the motor is coupled to the linear drive unit with **bell housing and motor flange adapter**.

Shafts are connected by a **torsionally rigid bellows coupling** with a **low moment of inertia**.

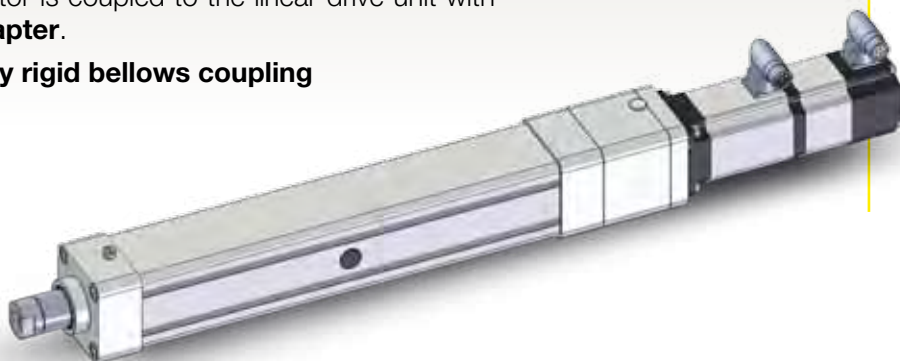

SA PD Series Servoactuator

“**Parallel Design**” execution driven by high performance, efficiency and accuracy **timing belt**. The linear unit and motor shafts have tapered ends.

Tapered shafts enables the direct fitting of the pulleys on the shafts, without other locking devices nor drive keys.

Conical clamping joints allow the transmission of motion **without any angular backlash**, no slipping on transmission elements. They also reduce the inertia of the moving masses and make the **solution also competitive** in price.

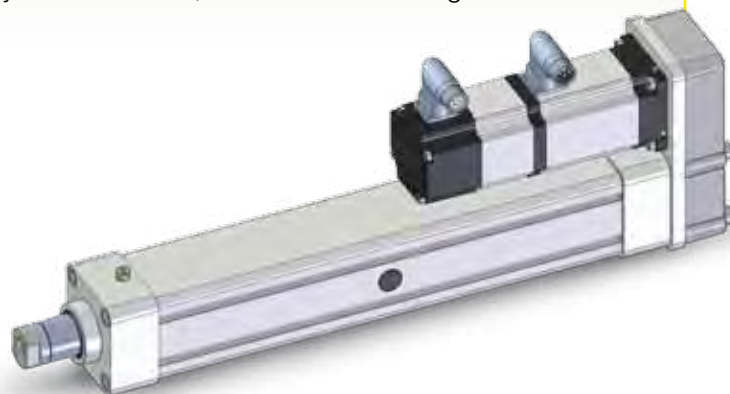

2.2 Construction Features

LINEARMECH servoactuators have a common linear drive unit.

SA IL Series Servoactuators

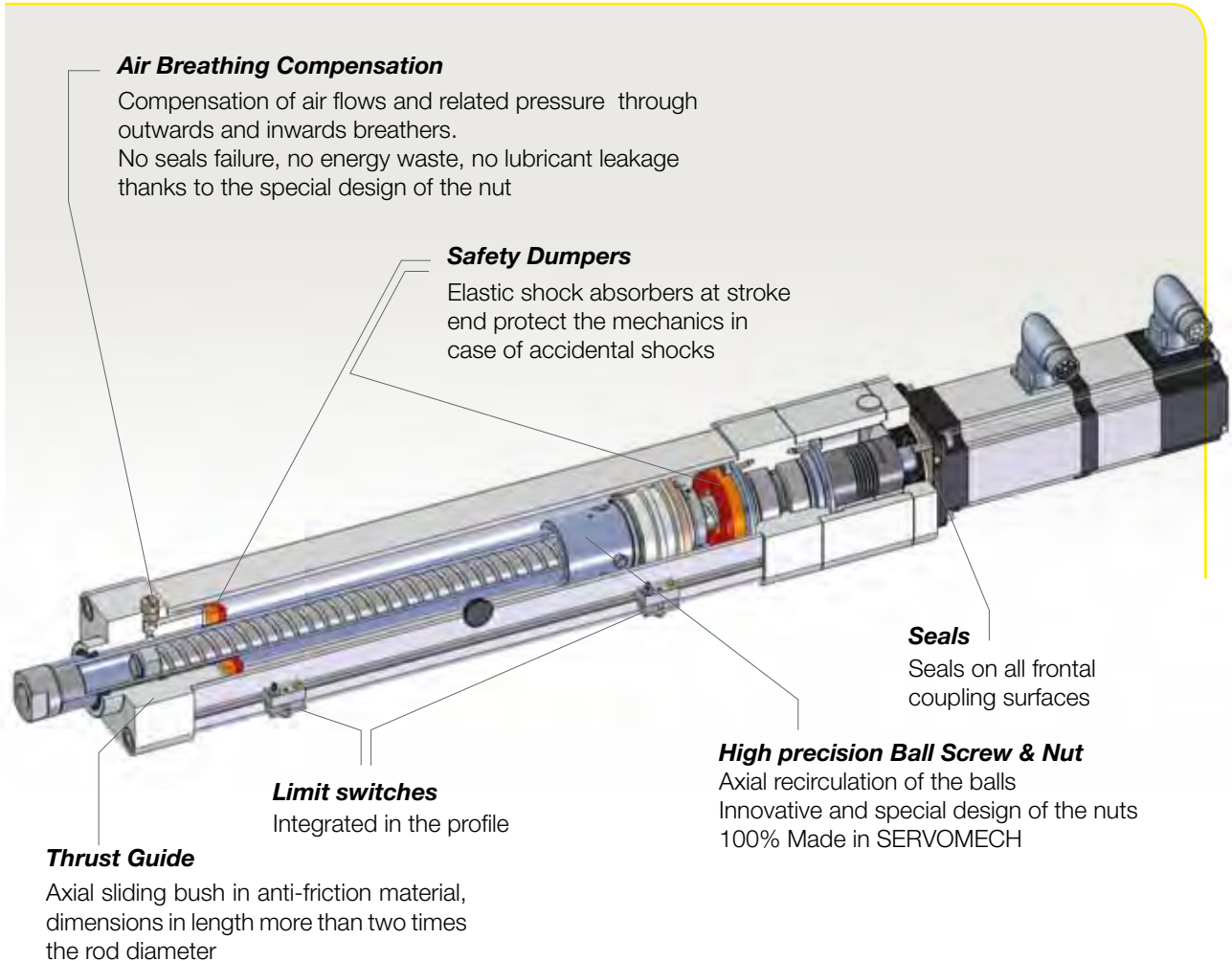

Particular care in the engineering of the bearings set for ball screw support.

Labyrinth seals: contactless seals to avoid wear, overheating and power losses.

Angular ball bearings or Tapered roller bearings (depending on the size of the actuator): screw support bearings with specific mounting type and centre distance to improve the overall stiffness of the system. Increased stiffness and accuracy during operation. Longer lifetime of bearings and ball nut.

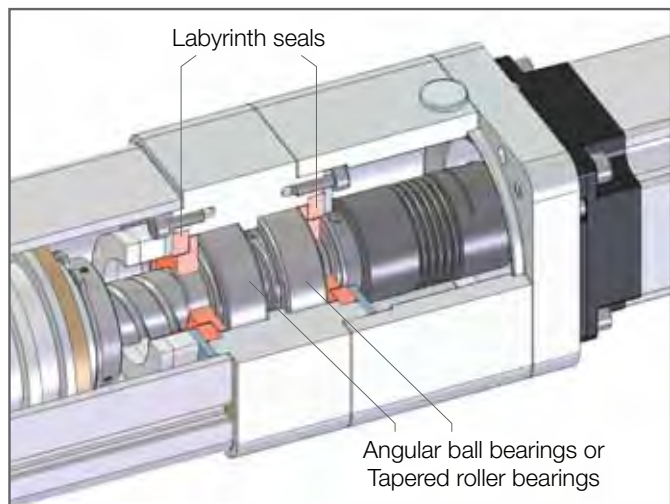

SA PD Series Servoactuator

Conical clamping joints

Transmission of the motion without any angular backlash, no slipping on the elements of the transmission. They reduce the inertia of the moving masses and make the solution particularly competitive in price

Lightweight Technology

Low inertia of the components thanks to high quality materials, with high resistance and light weight

Screw & Nut designed by SERVOMECH

Innovative design specifically developed to operate with high dynamic conditions and high speed

Brushless Servomotor with Brake

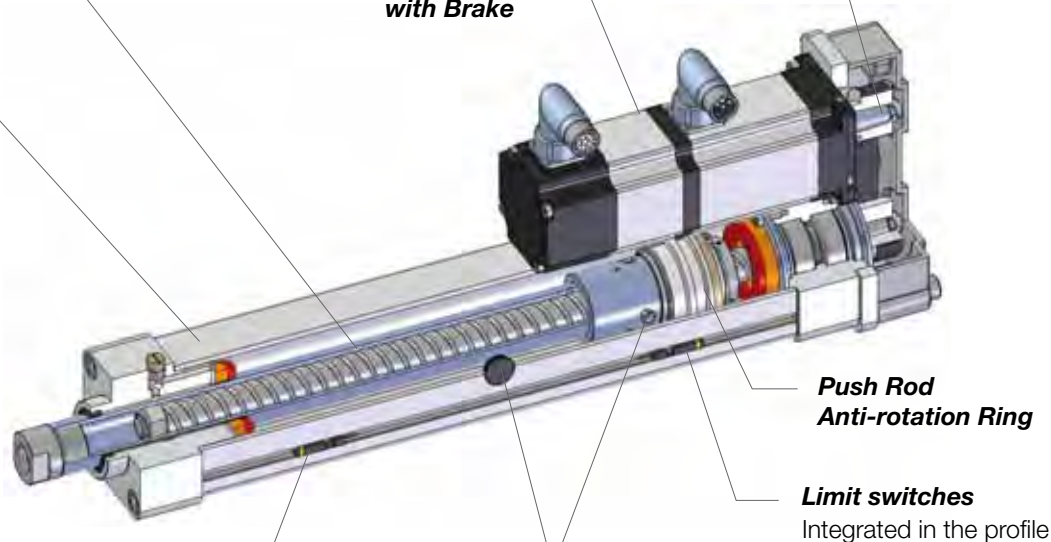

Push Rod Anti-rotation Ring

Limit switches
Integrated in the profile

Re-lubrication System

Integrated lubrication sealing system for the nut. The lubricant is only where is needed, no leakage even in case of high dynamic conditions. The anti-rotation ring on the ball nut allows an easy and fast lubrication: you only have to select the lubrication position. The lubrication hole on the outer square tube is exactly in correspondance with the grease nipple position located on the nut.

Limit switches
Integrated in the profile

2.3 Ball Screws and Nuts

Ball screws and nuts of LINEARMECH servoactuators are entirely **produced by SERVOMECH SpA** inside our factory in Anzola dell'Emilia (Bologna, Italy).

The standard production process of our servoactuators provides ball screws manufactured with **cold formed** alloy steel 42 CrMo 4 (EN 10083-1) bars, then quenched and **hardened by induction heating**. The resulting hardness of ball tracks is within the range (58 ... 61) HRc.

Ball nuts are manufactured in alloy steel 18 NiCrMo 5 (EN 10084). During the manufacturing process the **ball nuts are case-hardened**, in order to ensure a hardness of surfaces in contact within the range (58 ... 61) HRc.

Nuts with innovative design, specifically engineered for the optimal lubrication of the component inside the servoactuators, also designed to satisfy the high dynamic conditions needed during operations.

Axial recirculation of the balls inside the nut to provide a bigger quantity of balls in contact with screw and nut in comparison with standard solution with radial recirculation.

Two **sealing rings** on the edges keep the lubricant inside the nut. In correspondence to the rear sealing ring (on the left side of the picture) there is a **chamber for lubricant reserve**.

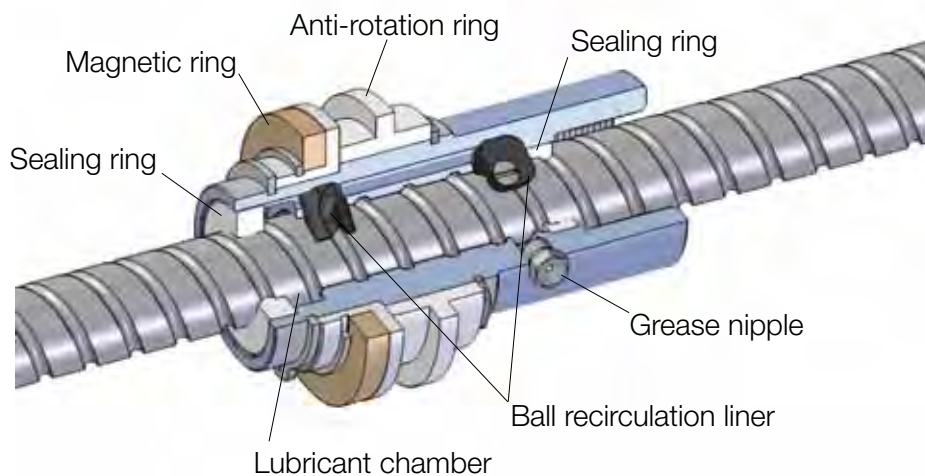

The **re-lubrication** is easy and quick: thanks to the grease nipple on the nut and the plastic anti-rotation ring. When you go into the lubrication position (for more information see Chapter 9 Lubrication), the hole on the outer square tube is exactly in correspondance with the grease nipple position located on the nut. The plastic **anti-rotation ring** fixed to the nut keeps the grease nipple in-line with the bore on the servoactuator outer tube.

Standard execution is provided with ball screws **accuracy grade IT 7**.

On request are available whirled ball screws with higher accuracy grade (**IT 5** or **IT 3**), zero backlash nuts or preloaded nuts.

For further information and to select the proper solution for your application, please contact our technical support.

2.4 Construction Technology

During the design phase, we have carefully evaluated all critical areas that could involve these components during their service life, to be able to offer a really innovative product.



High Dynamic Efficiency Technology

Everything you need to operate with high dynamic conditions.

- High quality materials to have both great strength with low inertia
- Compensation of air flows to eliminate any waste of energy needed to overcome internal pressures
- Contactless labyrinth seals to prevent wear, overheating and friction losses
- High precision and efficiency ball screws and nuts made by SERVOMECH



Stiffness for Motion Technology

Strength and rigidity during the transmission of the motion.

- Axial recirculation of the balls inside the nut to increase both load capacity and overall stiffness of the system
- Angular ball bearings or tapered roller bearings (depending on the actuator size) to increase the stiffness and the accuracy during the operation
- Thrust guide through an axial sliding bush in anti-friction material, length dimensions more than two times the rod diameter, to provide a better support and thrust guide also in event of lateral loads
- Ball screw nuts with innovative design made by SERVOMECH



Accuracy and Repeatability Management System

Positioning accuracy and repeatability guaranteed.

- High precision ball screws and nuts made by SERVOMECH
- Zero axial clearance among the components thanks to the machining accuracy (components 100% Made by SERVOMECH)
- Conical clamping joints allow the transmission of motion without any angular backlash, no slipping on the transmission elements
- Native integration of all components, designed and optimized to work together and give the best performances
- Integrated mechatronics functions inside the drive for the linear motion in the Automation Industry



Extended Service Life Technology

System safety and reliability, extended service life of all the components.

- Safety dumpers
- Limit switches
- Lubricant sealing system integrated

3.1 Technical Data

SIZE		SA 0		SA 1		SA 2			SA 3		
Profile ISO 15552	[mm]	□ 45		□ 52		□ 65			□ 75		
Rod diameter	[mm]	∅ 20		∅ 22		∅ 25			∅ 30		
Front attachment thread	[mm]	M10 × 1.25 depth 15 mm		M12 × 1.25 depth 20 mm		M12 × 1.25 depth 20 mm			M16 × 1.5 depth 24 mm		
Input shaft diameter	[mm]	∅ 9		∅ 9		∅ 11			∅ 14		
Max. load F_{max} ⁽¹⁾	[N]	5500		5500		6400			8600		
Ball screw BS		BS1	BS2	BS1	BS2	BS1	BS2	BS3	BS1	BS2	BS3
Diameter × Lead ($d_o \times P_h$)	[mm]	12 × 5	12 × 10	14 × 5	14 × 10	16 × 5	16 × 10	16 × 16	20 × 5	20 × 10	20 × 20
Ball (D_w)	[mm]	∅ 2.381		∅ 3.175		∅ 3.175			∅ 3.175		
Accuracy grade ⁽²⁾		IT 7		IT 7		IT 7			IT 7		
N° of circuits		3	2	3	2	4	3	2	4	3	2
N° of starts		1	2	1	1	1	1	2	1	1	2
Dynamic load (C_a)	[N]	5300	6600	7800	5300	11100	8900	10500	12800	10200	12100
Static load (C_{0a})	[N]	8000	9500	11100	6900	18100	14400	15700	24400	18900	20900
Linear travel for 1 motor shaft revolution	[mm]	5	10	5	10	5	10	16	5	10	20
Max. input speed n_{max}	[rpm]	7500		6430		5625			4500		
Max. linear speed v_{max}	[mm/s]	625	1250	536	1072	470	937	1875	375	750	1500
Total actuator efficiency (η)		0.86	0.88	0.85	0.88	0.85	0.87	0.88	0.84	0.87	0.88
Mass in linear motion (m) and moment of inertia (J) of the actuator reduced to motor shaft											
m_o ref. to 0 mm stroke	[kg]	0.32	0.32	0.47	0.48	0.61	0.62	0.61	1.00	1.00	1.00
m_{100} for each 100 mm extra-stroke	[kg]	0.13		0.14		0.19			0.20		
J_o ref. to 0 mm stroke actuator	[kg×m ²]	3.9×10 ⁻⁶	4.6×10 ⁻⁶	5.5×10 ⁻⁶	6.5×10 ⁻⁶	1.4×10 ⁻⁵	1.5×10 ⁻⁵	1.8×10 ⁻⁵	3.5×10 ⁻⁵	3.7×10 ⁻⁵	4.5×10 ⁻⁵
J_{100} for each 100 mm extra-stroke	[kg×m ²]	1.8×10 ⁻⁶	2.0×10 ⁻⁶	2.6×10 ⁻⁶	2.9×10 ⁻⁶	4.5×10 ⁻⁶	4.9×10 ⁻⁶	5.7×10 ⁻⁶	1.1×10 ⁻⁵	1.2×10 ⁻⁵	1.3×10 ⁻⁵
Weight of 100 mm stroke actuator ⁽³⁾	[kg]	1.8		2.3		3.4			4.8		
Extra-weight for each 100 mm extra-stroke	[kg]	0.44		0.51		0.67			0.79		
Operating temperature	°C	10 ... 40									

⁽¹⁾ - pull or push

⁽²⁾ - ball screws with accuracy grade IT 3 or IT 5 available on request

⁽³⁾ - weight of actuator without accessories

3.1 Technical Data

SA 4			SA 5				SA 6				SIZE
□ 95			□ 115				□ 140				[mm] Profile ISO 15552
∅ 35			∅ 50				∅ 60				[mm] Rod diameter
M20 × 1.5 depth 30 mm			M20 × 1.5 depth 40 mm				M27 × 2 depth 54 mm				[mm] Front attachment thread
∅ 19			∅ 19				∅ 24				[mm] Input shaft diameter
12000			37000				46000				[N] Max. load $F_{max}^{(1)}$
BS1	BS2	BS3	BS1	BS2	BS3	BS4	BS1	BS2	BS3	BS4	Ball screw BS
25 × 5	25 × 10	25 × 25	32 × 5	32 × 10	32 × 20	32 × 32	40 × 5	40 × 10	40 × 20	40 × 40	[mm] Diameter × Lead ($d_o \times P_h$)
∅ 3.175	∅ 3.969	∅ 3.175	∅ 3.175	∅ 6.350	∅ 6.350	∅ 6.350	∅ 3.175	∅ 6.350	∅ 6.350	∅ 6.350	[mm] Ball (D_w)
IT 7			IT 7				IT 7				Accuracy grade $(^2)$
4	3	2	6	4	3	2	6	4	3	2	N° of circuits
1	1	2	1	1	1	2	1	1	1	2	N° of starts
14500	14800	13600	23000	37000	29800	35000	25300	42800	34300	40300	[N] Dynamic load C_d
31500	28000	27300	60200	66800	53200	58100	76900	88900	70000	77100	[N] Static load C_{da}
5	10	25	5	10	20	32	5	10	20	40	[mm] Linear travel for 1 motor shaft revolution
3600			2810				2250				[rpm] Max. input speed n_{max}
300	600	1500	234	468	937	1500	187	375	750	1500	[mm/s] Max. linear speed v_{max}
0.82	0.86	0.88	0.80	0.85	0.87	0.88	0.78	0.84	0.87	0.88	Total actuator efficiency (η)
Mass in linear motion (m) and moment of inertia (J) of the actuator reduced to motor shaft											
1.45	1.44	1.46	3.37	3.22	3.26	3.19	4.90	4.90	4.90	4.90	[kg] m_o ref. to 0 mm stroke
0.24			0.49				0.62				[kg] m_{100} for each 100 mm extra-stroke
9.3×10^{-5}	9.6×10^{-5}	1.2×10^{-4}	3.3×10^{-4}	3.3×10^{-4}	3.6×10^{-4}	4.2×10^{-4}	8.3×10^{-4}	8.4×10^{-4}	8.8×10^{-4}	1.0×10^{-3}	[kg×m ²] J_o ref. to 0 mm stroke actuator
2.7×10^{-5}	2.8×10^{-5}	3.1×10^{-5}	6.9×10^{-5}	7.1×10^{-5}	7.5×10^{-5}	8.4×10^{-5}	1.8×10^{-4}	1.8×10^{-4}	1.9×10^{-4}	2.1×10^{-4}	[kg×m ²] J_{100} for each 100 mm extra-stroke
8.2			19				31				[kg] Weight of 100 mm stroke actuator $(^3)$
1.1			1.9				2.7				[kg] Extra-weight for each 100 mm extra-stroke
10 ... 40											°C Operating temperature

⁽¹⁾ - pull or push

⁽²⁾ - ball screws with accuracy grade IT 3 or IT 5 available on request

⁽³⁾ - weight of actuator without accessories

3.2 Dimensions

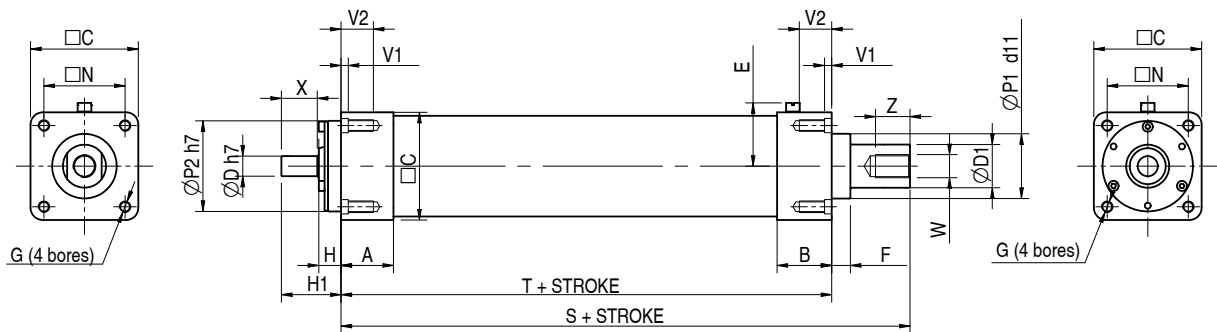

SIZE	SA 0	SA 1	SA 2	SA 3	SA 4	SA 5	SA 6
A	30	30	37	37	48	96	116
B	40	34	40	38	51.5	82	108
C	46	52	65	75	95	112	138
Ø D	7	9	11	14	19	19	24
Ø D1	20	22	25	30	35	50	60
E	30	32	39	44	54	-	-
F	21.5	10	13	13	5	8	8
G	M6	M6	M8	M8	M10	M10	M12
H	11	11	14	15.5	16.5	15.5	17.5
H1	30	30	39	41.5	47.5	56.5	57
N	32.5	38	46.5	56.5	72	89	110
Ø P1	30	35	40	45	45	70	80
Ø P2	40	40	50	63	80	100	125
S	229	246	264	296	330	453	538
T	203	205	217	241	284	396	474
V1	4.5	4.5	5.5	5.5	5.5	25	30
V2	17.5	17.5	22.5	22.5	27.5	-	-
W	M10 × 1.25	M12 × 1.25	M12 × 1.25	M16 × 1.5	M20 × 1.5	M20 × 1.5	M27 × 2
X	18	18	23	25	28	28	28
Z	15	20	20	24	30	40	54

Standard stroke lengths:

Stroke [mm]	100	200	300	400	500	600	700	800	900	1000
SA 0	C100	C200	C300	-	-	-	-	-	-	-
SA 1	C100	C200	C300	C400	-	-	-	-	-	-
SA 2	C100	C200	C300	C400	C500	C600	-	-	-	-
SA 3	C100	C200	C300	C400	C500	C600	C700	C800	-	-
SA 4	C100	C200	C300	C400	C500	C600	C700	C800	-	-
SA 5	C100	C200	C300	C400	C500	C600	C700	C800	C900	C1000
SA 6	C100	C200	C300	C400	C500	C600	C700	C800	C900	C1000

NOTES

Available accessories, dimensions and orientation: please refer to page 24 *SA IL: Accessories Dimensions*.
Input shaft versions:

- Vers. 1: cylindrical input shaft (standard); special executions in different dimensions, with or without key, available on request
- Vers. 5: interface for coupling to fit motors / servomotors supplied by customer (on request).

3.3 Performances

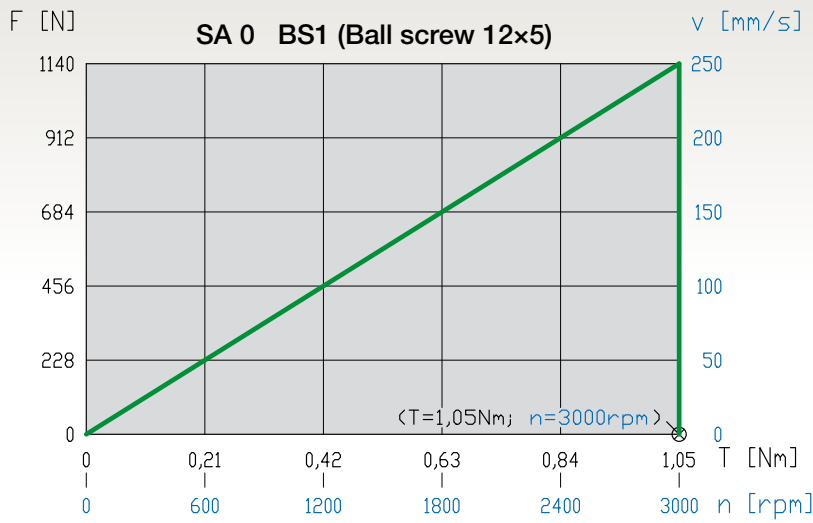

3.3.1 SA 0

Following diagrams show, for each actuator size, the relation between:

- Linear speed v [mm/s] depending on actuator input speed n [rpm]
- Actuator force F [N] depending on input torque T [Nm]

Different values not included in the diagrams can be calculated by linear interpolation.

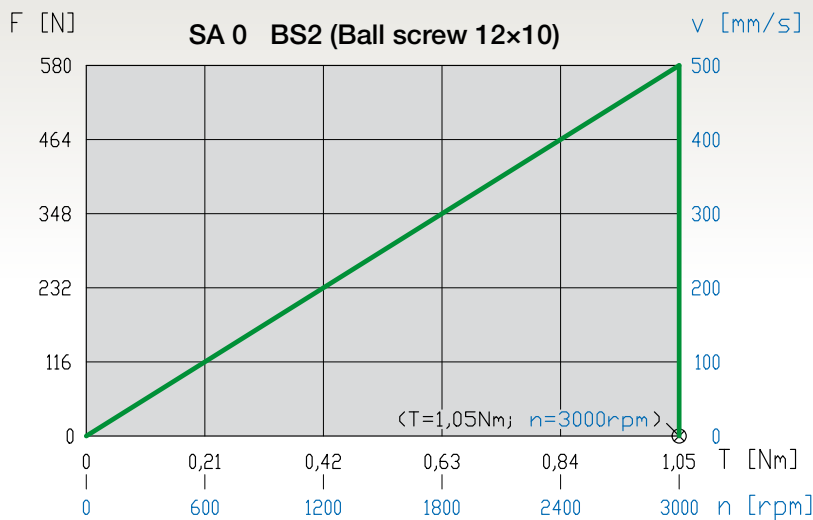

3.3.1 SA 0

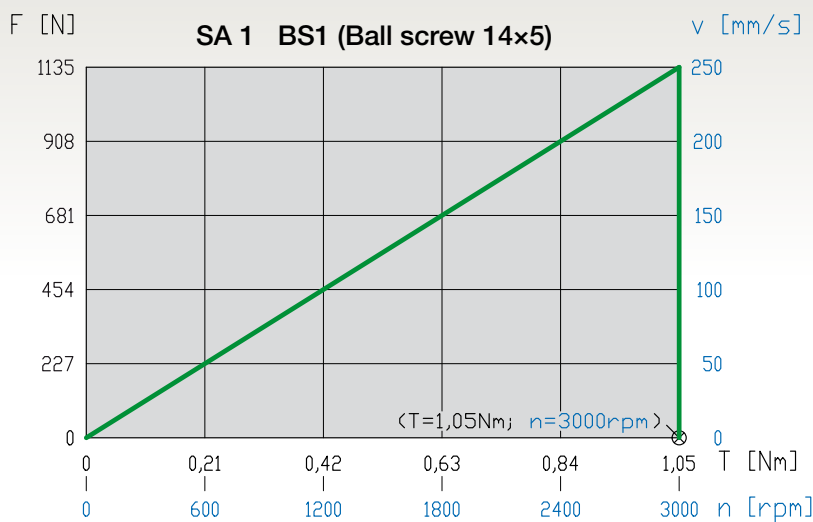

3.3.2 SA 1

3.3 Performances

3.3.2 SA 1

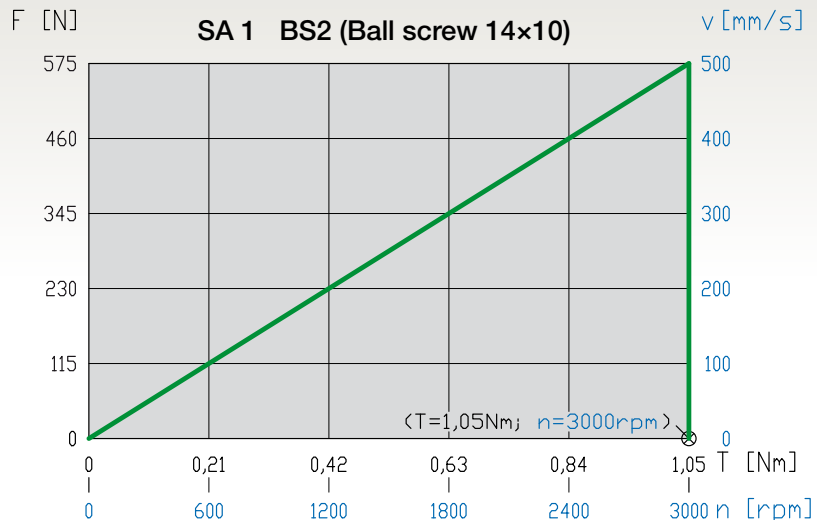

3.3.3 SA 2

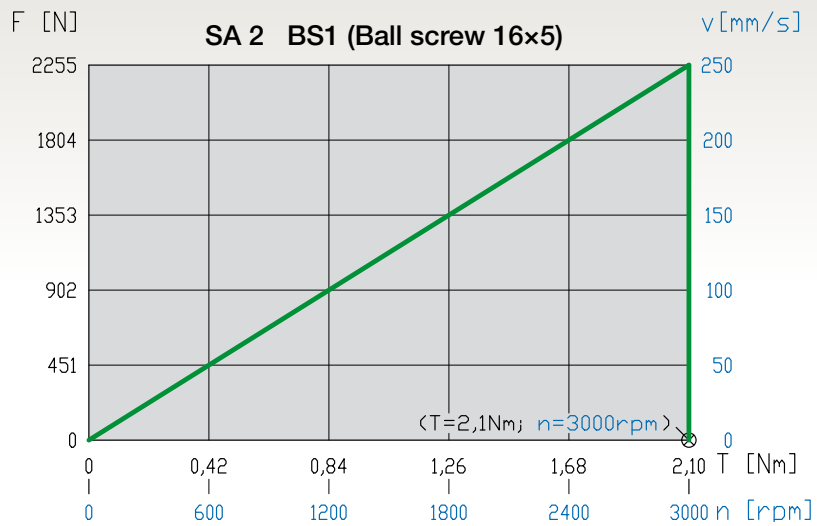

3.3.3 SA 2

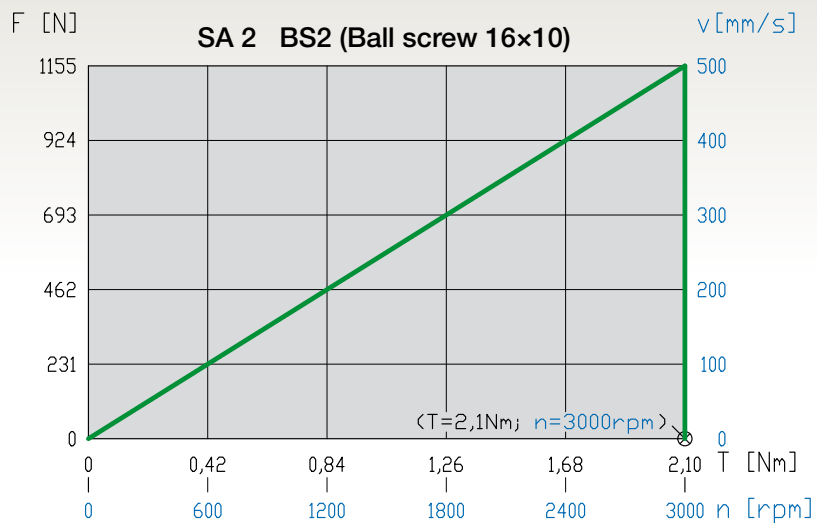

3.3 Performances

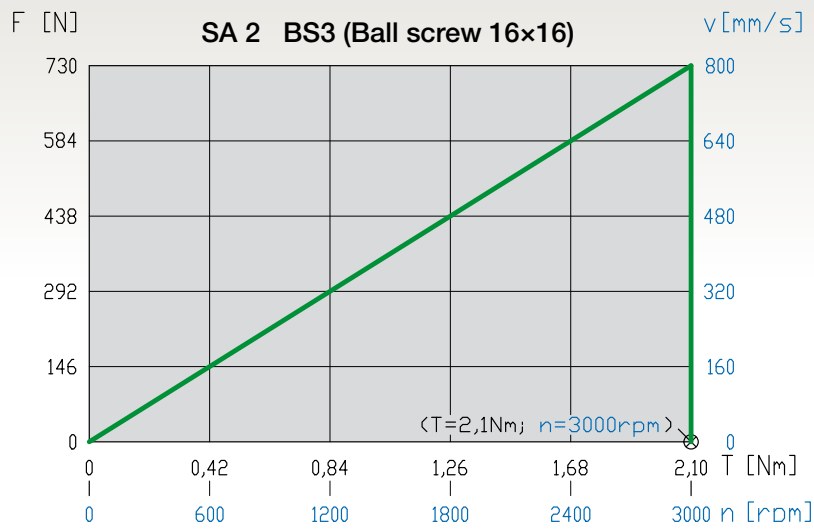

3.3.3 SA 2

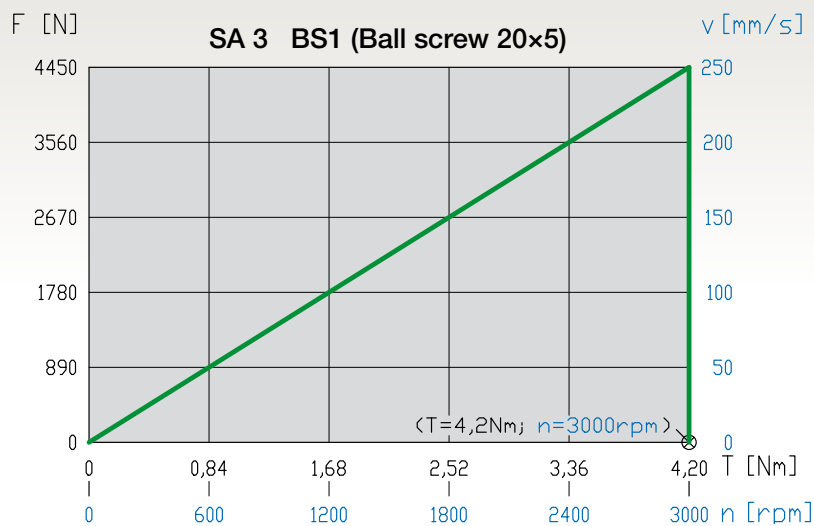

3.3.4 SA 3

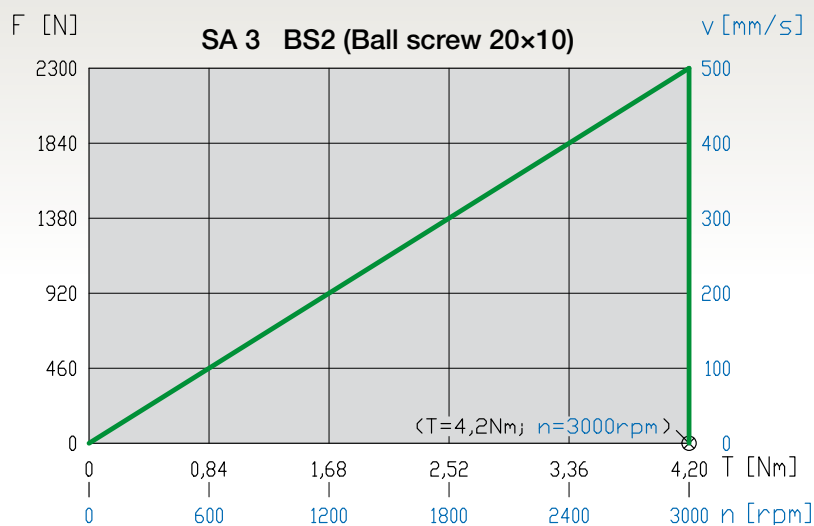

3.3.4 SA 3

3.3 Performances

3.3.4 SA 3

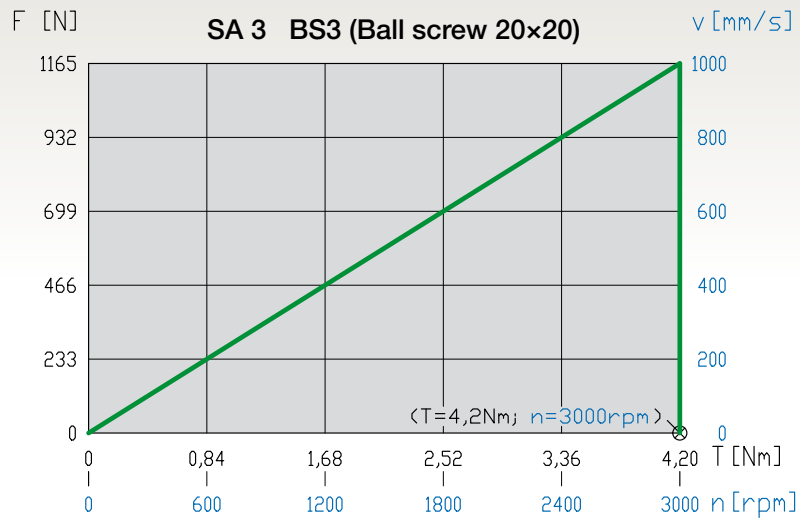

3.3.5 SA 4

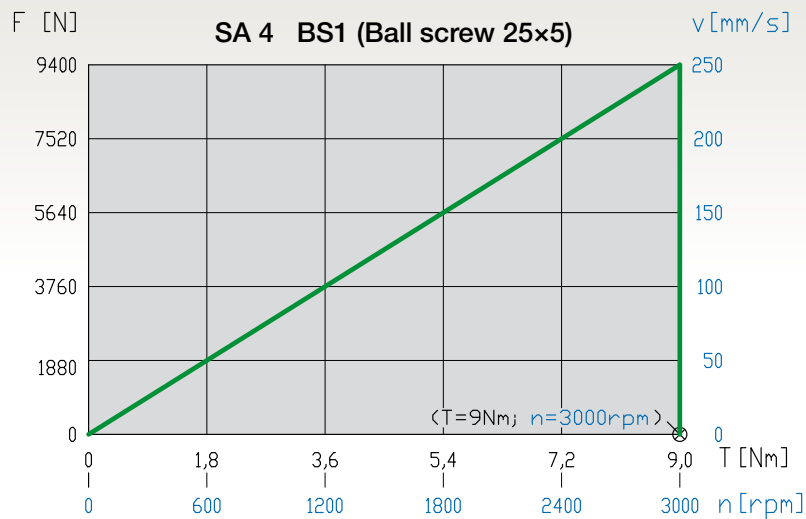

3.3.5 SA 4

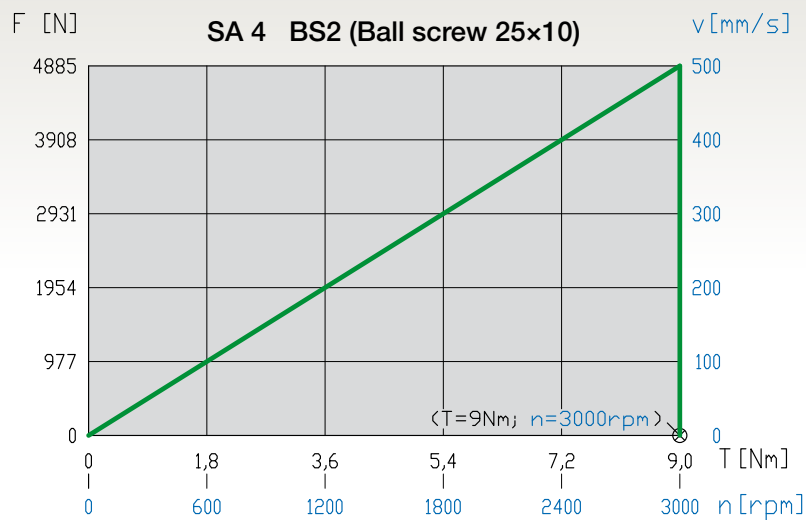

3.3 Performances

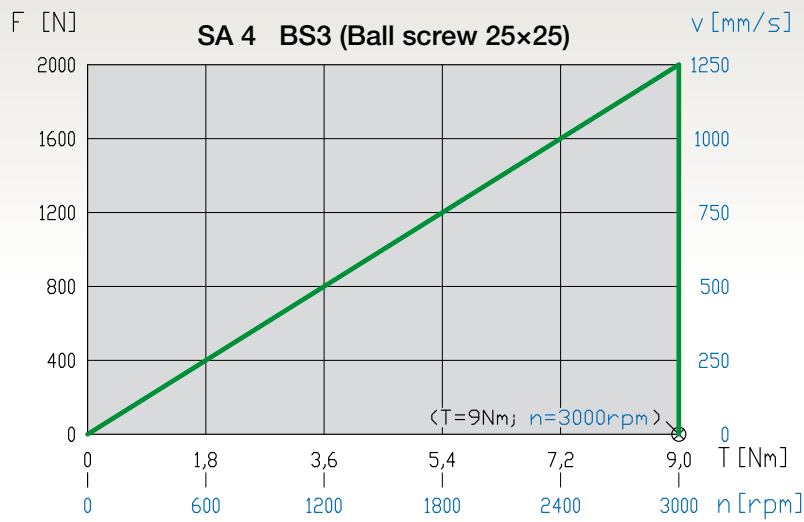

3.3.5 SA 4

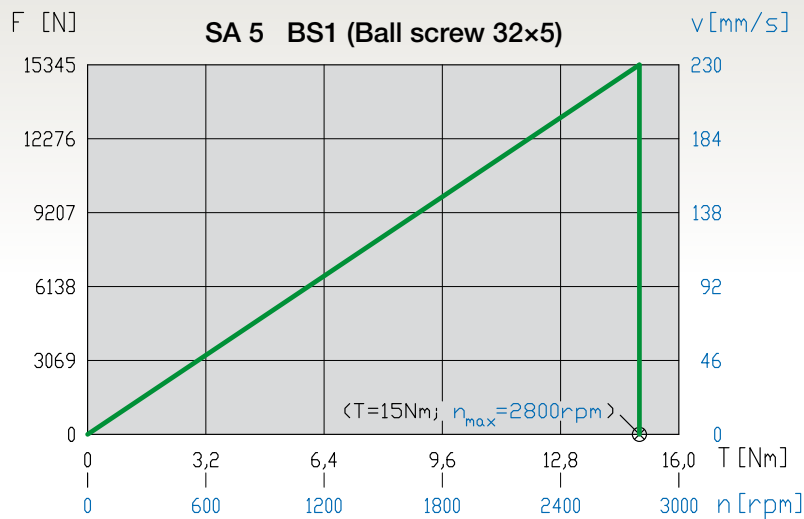

3.3.6 SA 5

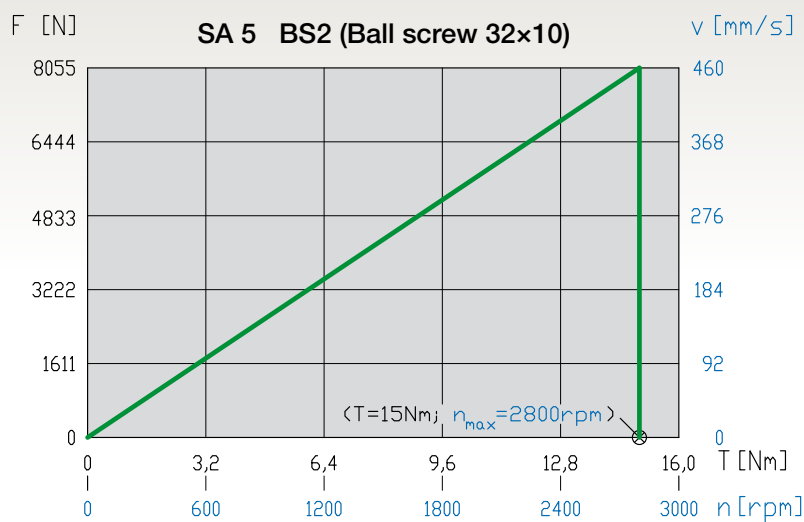

3.3.6 SA 5

3.3 Performances

3.3.6 SA 5

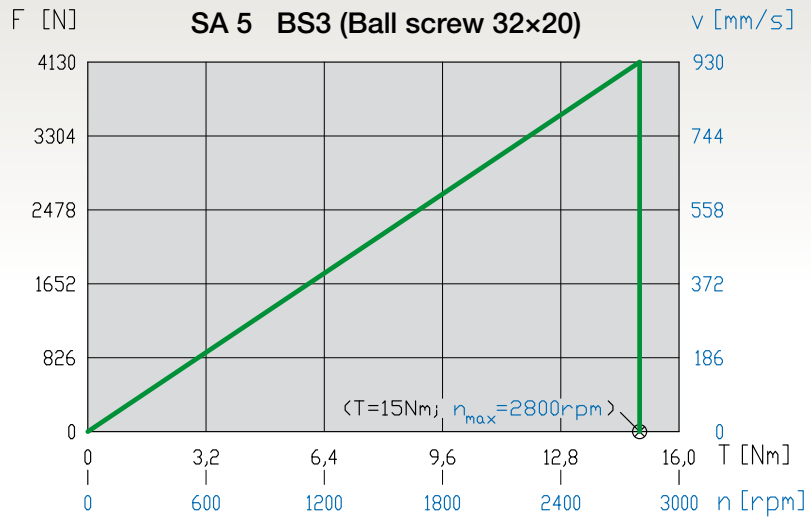

3.3.6 SA 5

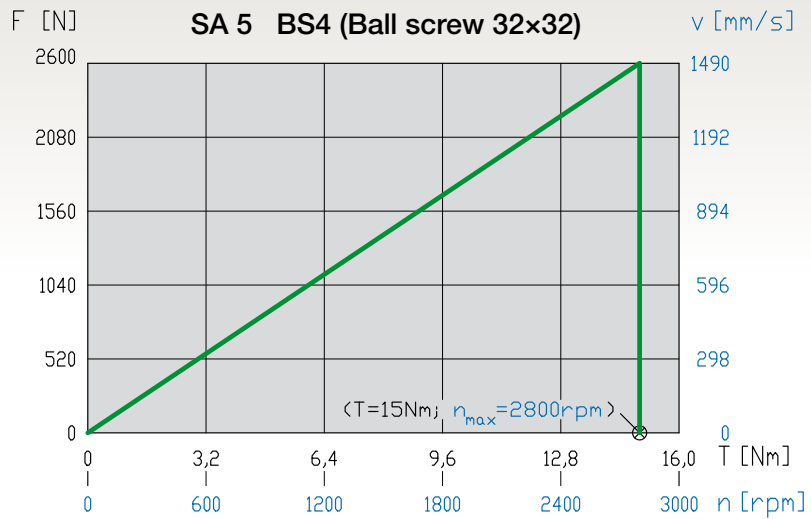

3.3.7 SA 6

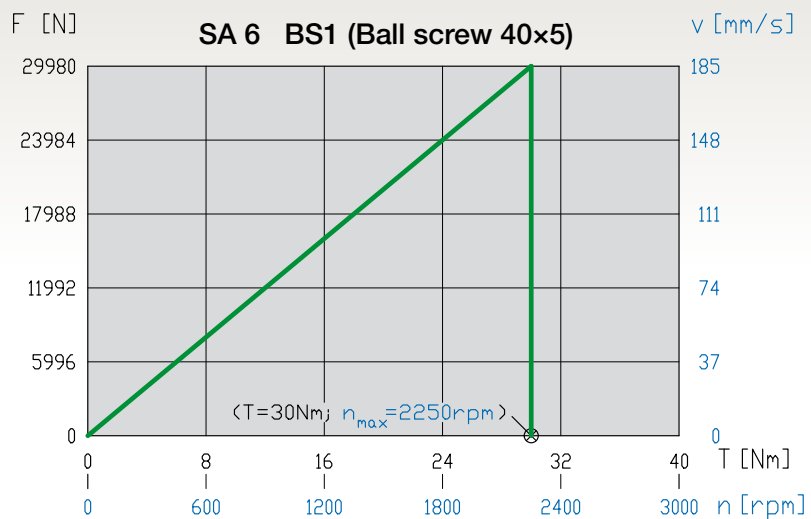

3.3 Performances

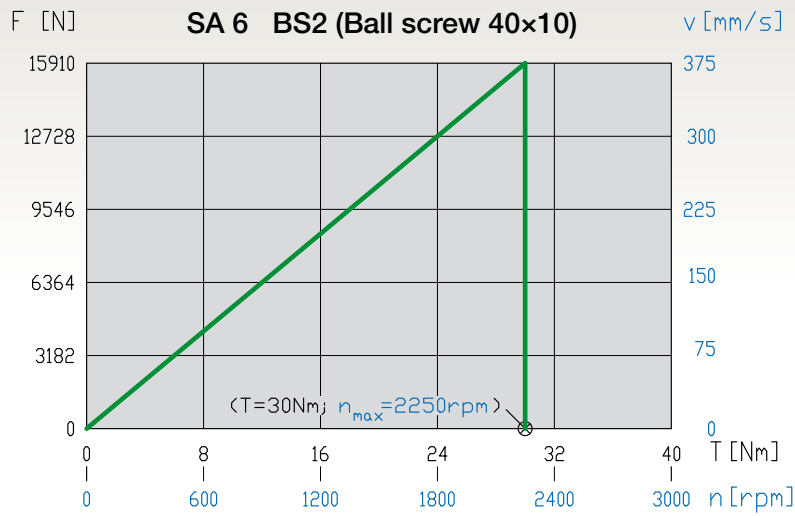

3.3.7 SA 6

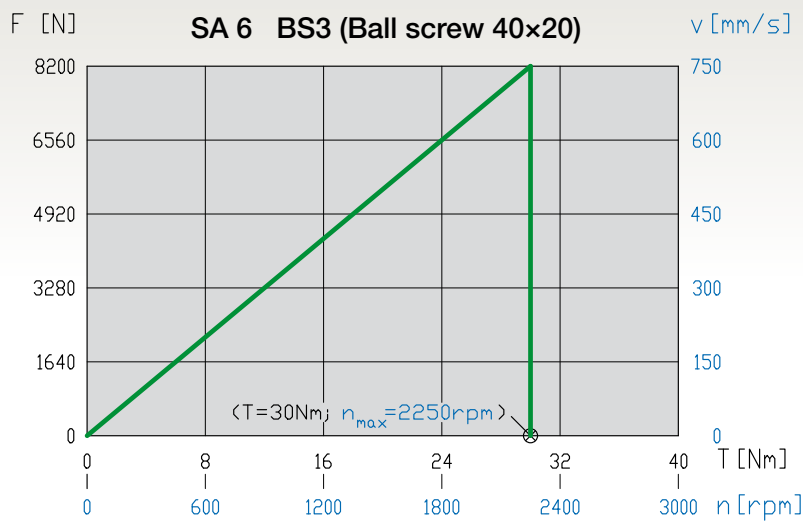

3.3.7 SA 6

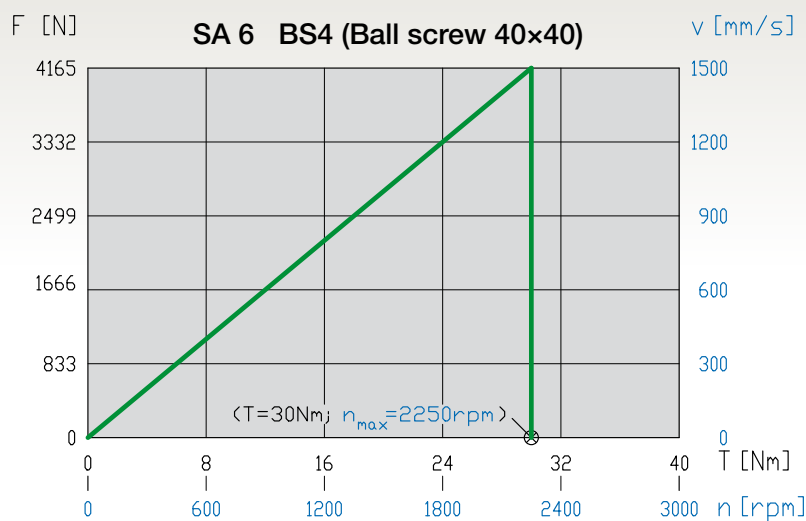

3.3.7 SA 6

4.1 Technical Data

SIZE		SA 0 IL		SA 1 IL		SA 2 IL			SA 3 IL		
Profile ISO 15552	[mm]	□ 45		□ 52		□ 65			□ 75		
Rod diameter	[mm]	∅ 20		∅ 22		∅ 25			∅ 30		
Front attachment thread	[mm]	M10 × 1.25 depth 15 mm		M12 × 1.25 depth 20 mm		M12 × 1.25 depth 20 mm			M16 × 1.5 Depth 24 mm		
Ball screw BS		BS1	BS2	BS1	BS2	BS1	BS2	BS3	BS1	BS2	BS3
Diameter × Lead ($d_o \times P_h$)	[mm]	12 × 5	12 × 10	14 × 5	14 × 10	16 × 5	16 × 10	16 × 16	20 × 5	20 × 10	20 × 20
Ball (D_w)	[mm]	∅ 2.381		∅ 3.175		∅ 3.175			∅ 3.175		
Accuracy grade (°)		IT 7		IT 7		IT 7			IT 7		
N° of circuits		3	2	3	2	4	3	2	4	3	2
N° of starts		1	2	1	1	1	1	2	1	1	2
Dynamic load (C_a)	[N]	5300	6600	7800	5300	11100	8900	10500	12800	10200	12100
Static load (C_{0a})	[N]	8000	9500	11100	6900	18100	14400	15700	24400	18900	20900
Brushless servomotor		BM 45 L - 30		BM 45 L - 30		BM 63 S - 30			BM 63 L - 30		
Peak torque T_p (°)	[Nm]	1.05		1.05		2.1			4.2		
Stall torque $T_{0,100K}$	[Nm]	0.35		0.35		0.7			1.4		
Rated torque $T_{nom,100K}$	[Nm]	0.32		0.32		0.6			1.3		
Nominal speed n_{nom}	[rpm]	3000		3000		3000			3000		
Ratio (u)		1 : 1		1 : 1		1 : 1			1 : 1		
Linear travel for 1 motor shaft revolution	[mm]	5	10	5	10	5	10	16	5	10	20
Peak load F_p (°)	[N]	1140	580	1135	575	2255	1155	730	4450	2300	1165
Continuous load at zero-speed F_0	[N]	380	190	375	185	750	385	240	1485	765	390
Continuous load at no-zero-speed F_{nom}	[N]	345	175	340	170	645	330	210	1380	710	360
Max. linear speed v_{max}	[mm/s]	250	500	250	500	250	500	800	250	500	1000
Total actuator efficiency (η)		0.86	0.88	0.85	0.88	0.85	0.87	0.88	0.84	0.87	0.88
Mass in linear motion (m) and moment of inertia (J) of the actuator reduced to motor shaft											
m_0 ref. to 0 mm stroke	[kg]	0.32	0.32	0.47	0.48	0.61	0.62	0.61	1.00	1.01	1.00
m_{100} for each 100 mm extra-stroke	[kg]	0.13		0.14		0.19			0.20		
J_0 ref. to 0 mm stroke actuator	without brake [kg×m ²]	1.7×10 ⁻⁵	1.7×10 ⁻⁵	1.8×10 ⁻⁵	1.9×10 ⁻⁵	4.3×10 ⁻⁵	4.4×10 ⁻⁵	4.7×10 ⁻⁵	7.7×10 ⁻⁵	7.9×10 ⁻⁵	8.7×10 ⁻⁵
	with brake [kg×m ²]	1.7×10 ⁻⁵	1.7×10 ⁻⁵	1.8×10 ⁻⁵	1.9×10 ⁻⁵	4.5×10 ⁻⁵	4.6×10 ⁻⁵	4.9×10 ⁻⁵	7.9×10 ⁻⁵	8.1×10 ⁻⁵	8.9×10 ⁻⁵
J_{100} for each 100 mm extra-stroke	[kg×m ²]	1.8×10 ⁻⁶	2.0×10 ⁻⁶	2.6×10 ⁻⁶	2.9×10 ⁻⁶	4.5×10 ⁻⁶	4.9×10 ⁻⁶	5.7×10 ⁻⁶	1.1×10 ⁻⁵	1.2×10 ⁻⁵	1.3×10 ⁻⁵
Weight of 100 mm stroke actuator (°)	[kg]	3.0 (3.3)		3.5 (3.8)		5.3 (6.0)			7.4 (8.1)		
Extra-weight for each 100 mm extra-stroke	[kg]	0.44		0.51		0.67			0.79		
Operating temperature	[°C]	10 ... 40									

(°) - ball screws with accuracy grade IT 3 or IT 5 available on request

(°) - valid only in case of intermittent working

(°) - weight of actuator without accessories

4.1 Technical Data

SA 4 IL			SA 5 IL				SA 6 IL				SIZE	
□ 95			□ 115				□ 140				[mm] Profile ISO 15552	
∅ 35			∅ 50				∅ 60				[mm] Rod diameter	
M20 × 1.5 depth 30 mm			M20 × 1.5 depth 40 mm				M27 × 2 depth 54 mm				[mm] Front attachment thread	
BS1	BS2	BS3	BS1	BS2	BS3	BS4	BS1	BS2	BS3	BS4	Ball screw BS	
25 × 5	25 × 10	25 × 25	32 × 5	32 × 10	32 × 20	32 × 32	40 × 5	40 × 10	40 × 20	40 × 40	[mm] Diameter × Lead ($d_o \times P_h$)	
∅ 3.175	∅ 3.969	∅ 3.175	∅ 3.175	∅ 6.350	∅ 6.350	∅ 6.350	∅ 3.175	∅ 6.350	∅ 6.350	∅ 6.350	[mm] Ball (D_w)	
IT 7			IT 7				IT 7				Accuracy grade (1)	
4	3	2	6	4	3	2	6	4	3	2	N° of circuits	
1	1	2	1	1	1	2	1	1	1	2	N° of starts	
14500	14800	13600	23000	37000	29800	35000	25300	42800	34300	40300	[N] Dynamic load C_u	
31500	28000	27300	60200	66800	53200	58100	76900	88900	70000	77100	[N] Static load C_{0a}	
BM 82 L - 30			BM 102 S - 30				BM 102 L6 - 30		BM 102 L8 - 30		Brushless servomotor	
9			15				22		30		Peak torque T_p (2)	
3			5.2				7.3		9		Stall torque $T_{0,100K}$	
2.5			4.1				6.4		6.7		Rated torque $T_{nom,100K}$	
3000			3000				3000		3000		Nominal speed n_{nom}	
1 : 1			1 : 1				1 : 1		1 : 1		Ratio (u)	
5	10	25	5	10	20	32	5	10	20	40	[mm] Linear travel for 1 motor shaft revolution	
9400	4885	2000	15345	8055	4130	2605	21985 29975	11665 15910	6015 8205	3055 4165	[N] Peak load F_p (2)	
3135	1630	670	5320	2790	1430	900	7295 8995	3870 4775	1995 2460	1015 1250	[N] Continuous load at zero speed F_0	
2610	1360	555	4270	2240	1150	725	6620 7270	3515 3860	1810 1990	920 1010	[N] Continuous load at no-zero-speed F_{nom}	
250	500	1250	230	460	930	1490	185	375	750	1500	[mm/s] Max. linear speed v_{max}	
0.82	0.86	0.88	0.80	0.85	0.87	0.88	0.78	0.84	0.87	0.88	Total actuator efficiency (η)	
Mass in linear motion (m) and moment of inertia (J) of the actuator reduced to motor shaft												
1.45	1.44	1.46	3.37	3.22	3.26	3.19	4.90	4.90	4.90	4.90	[kg] m_0 ref. to 0 mm stroke	
0.24			0.49				0.62					[kg] m_{100} ref. to each 100 mm extra-stroke
2.2×10^{-4}	2.3×10^{-4}	2.5×10^{-4}	7.9×10^{-4}	8.0×10^{-4}	8.3×10^{-4}	8.8×10^{-4}	1.7×10^{-3}	1.7×10^{-3}	1.8×10^{-3}	1.9×10^{-3}	[kg·m ²] without brake J_0 ref. to 0 mm stroke actuator	
2.4×10^{-4}	2.4×10^{-4}	2.6×10^{-4}	8.4×10^{-4}	8.5×10^{-4}	8.7×10^{-4}	9.3×10^{-4}	1.7×10^{-3}	1.8×10^{-3}	1.8×10^{-3}	2.0×10^{-3}	[kg·m ²] with brake	
2.7×10^{-5}	2.8×10^{-5}	3.1×10^{-5}	6.9×10^{-5}	7.1×10^{-5}	7.5×10^{-5}	8.4×10^{-5}	1.8×10^{-4}	1.8×10^{-4}	1.8×10^{-4}	2.1×10^{-4}	[kg·m ²] J_{100} for each 100 mm extra-stroke	
13 (15)			25 (26)				39 (41)					[kg] Weight of 100 mm stroke actuator (3)
1.1			1.9				2.7					[kg] Extra-weight for each 100 mm extra-stroke
10 ... 40											[°C] Operating temperature	

(1) - ball screws with accuracy grade IT 3 or IT 5 available on request

(2) - valid only in case of intermittent working

(3) - weight of actuator without accessories

4.2 Dimensions

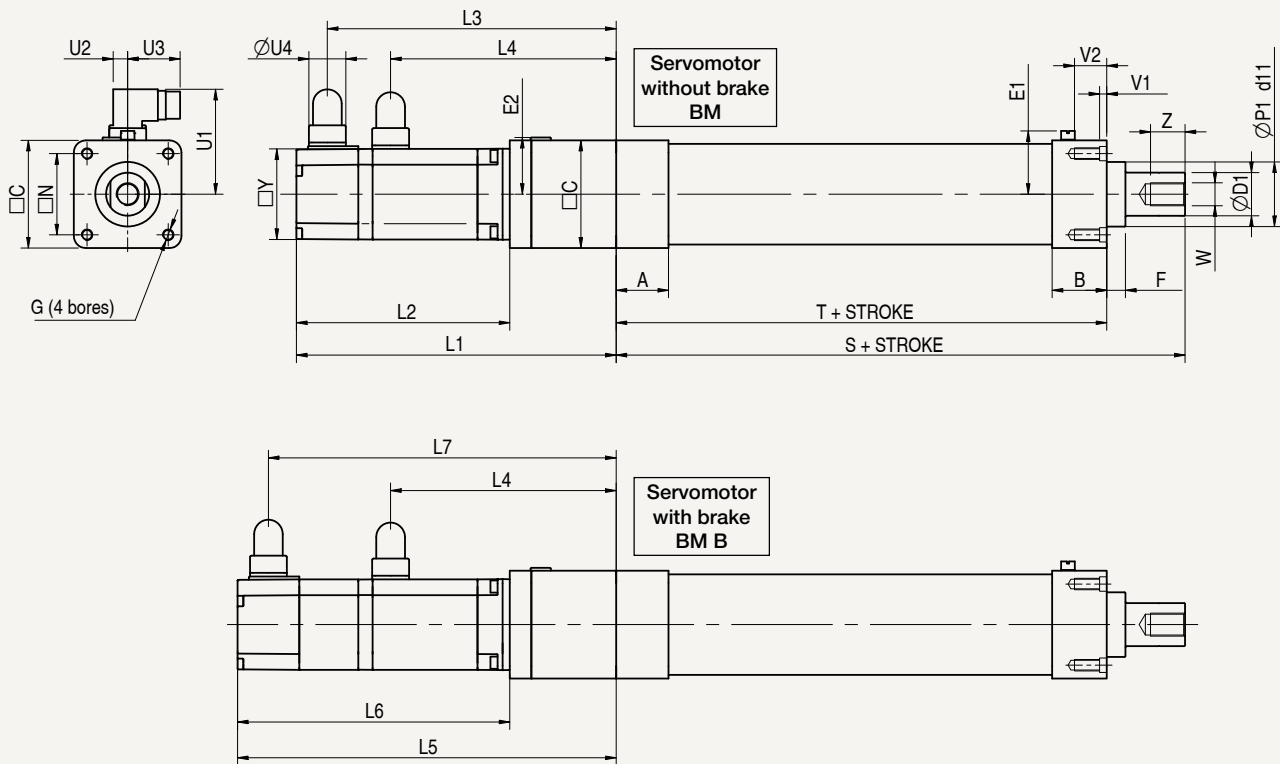

Servomotor mounting positions related to the limit switches

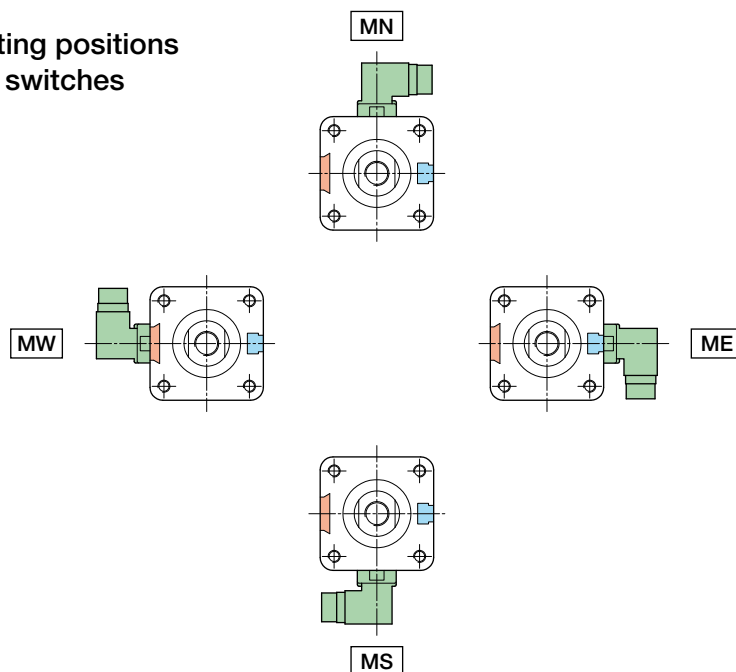

4.2 Dimensions

SIZE	SA 0 IL	SA 1 IL	SA 2 IL	SA 3 IL	SA 4 IL	SA 5 IL	SA 6 IL
A	30	30	37	37	48	96	116
B	40	34	40	38	51.5	82	108
□ C	46	52	65	75	95	112	138
∅ D1	20	22	25	30	35	50	60
E1	30	32	39	44	54	-	-
E2	24.5	28	34.5	39.5	49.5	60	73.5
F	21.5	10	13	13	5	8	8
G	M6	M6	M8	M8	M10	M10	M12
L1	184	183	198	223	251	305	355
L2	123	123	124	149	160	177	227
L3	164	163	176	201	229	283	335
L4	119	118	132	157	185	233	283
L5	217	216	239	264	309	359	409
L6	156	156	165	190	218	231	281
L7	152.5	151.5	173	198	287	337	389
□ N	32.5	38	46.5	56.5	72	89	110
∅ P1	30	35	40	45	45	70	80
S	229	246	264	296	330	453	538
T	203	205	217	241	284	396	474
U1	66	66	73	73	85	94.5	94.5
U2	10	10	10	10	14	14	14
U3	36.5	36.5	36.5	36.5	41	41	41
∅ U4	26	26	26	26	28	28	28
V1	4.5	4.5	5.5	5.5	5.5	25	30
V2	17.5	17.5	22.5	22.5	27.5	-	-
W	M10 × 1.25	M12 × 1.25	M12 × 1.25	M16 × 1.5	M20 × 1.5	M20 × 1.5	M27 × 2
□ Y	45	45	63	63	82	102	102
Z	15	20	20	24	30	40	54

Standard stroke lengths:

Stroke [mm]	100	200	300	400	500	600	700	800	900	1000
SA 0 IL	C100	C200	C300	-	-	-	-	-	-	-
SA 1 IL	C100	C200	C300	C400	-	-	-	-	-	-
SA 2 IL	C100	C200	C300	C400	C500	C600	-	-	-	-
SA 3 IL	C100	C200	C300	C400	C500	C600	C700	C800	-	-
SA 4 IL	C100	C200	C300	C400	C500	C600	C700	C800	-	-
SA 5 IL	C100	C200	C300	C400	C500	C600	C700	C800	C900	C1000
SA 6 IL	C100	C200	C300	C400	C500	C600	C700	C800	C900	C1000

4.3 Accessories Dimensions

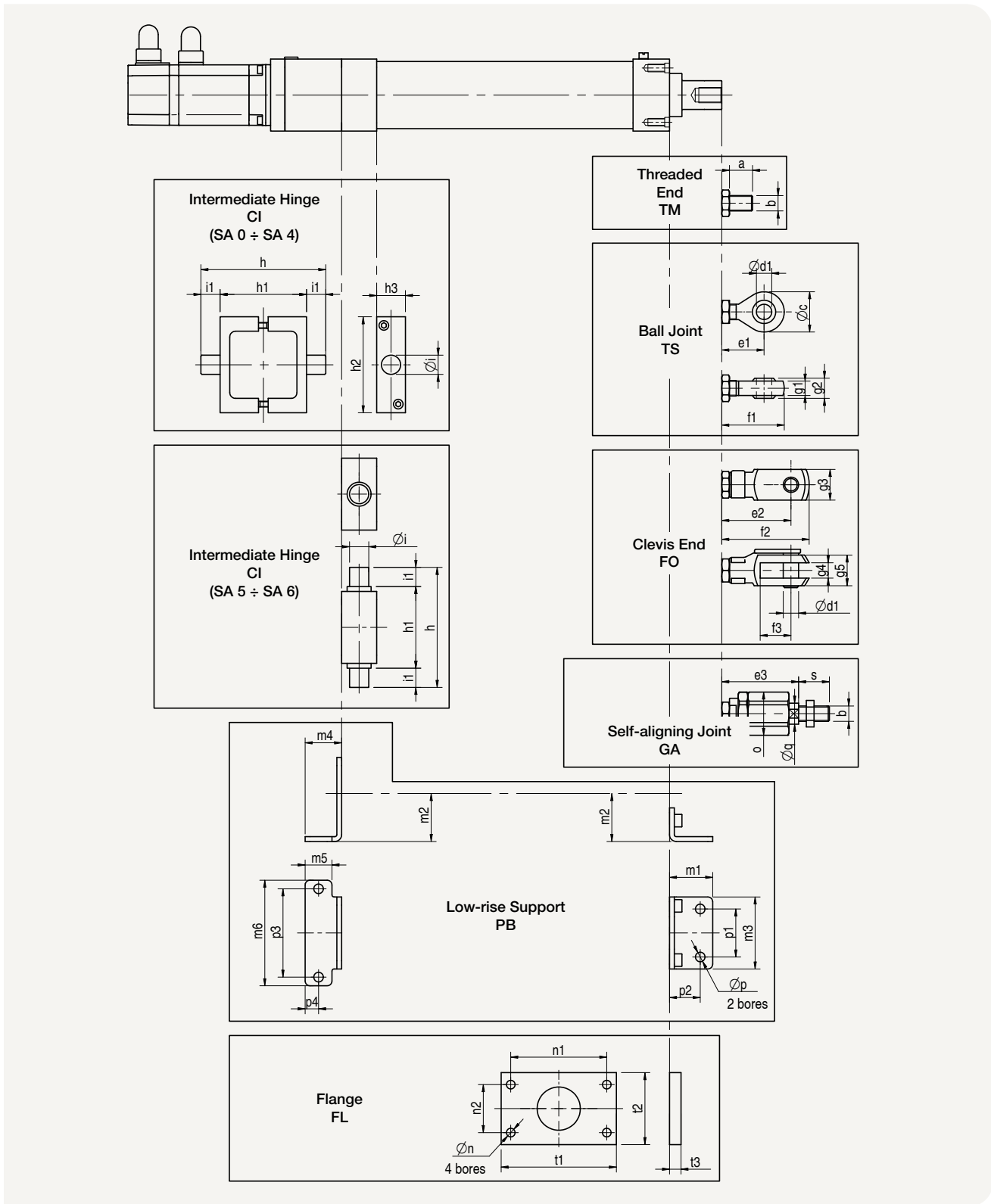

NOTE: Front attachments TS and FO must be aligned during assembling with the rear hinge axis; avoid any torsional load on the shaft to prevent damages on the anti-rotation device.

4.3 Accessories Dimensions

SIZE	SA 0 IL	SA 1 IL	SA 2 IL	SA 3 IL	SA 4 IL	SA 5 IL	SA 6 IL
a	15	20	20	24	30	40	54
b	M10 × 1.25	M12 × 1.25	M12 × 1.25	M16 × 1.5	M20 × 1.5	M20 × 1.5	M27 × 2
∅ c	28	32	32	42	50	50	70
∅ d1	10	12	12	16	20	20	30
e1	35	36	36	44	50	50	125
e2	46	55	55	72	89	89	122
e3	57.5	58.5	58.5	80	88	88	105
f1	49	52	52	65	75	75	160
f2	58	69	69	91	114	114	160
f3	20	24	24	32	40	40	54
g1	10.5	12	12	15	18	18	25
g2	14	16	16	21	25	25	37
g3	20	24	24	32	40	40	55
g4	10	12	12	16	20	20	30
g5	20	24	24	32	40	40	55
h	74	95	105	130	148	182	210
h1	50	63	73	90	108	132	160
h2	74	80	90	100	130	-	-
h3	25	25	25	30	30	-	-
∅ i	12	16	16	20	20	25	25
i1	12	16	16	20	20	25	25
m1	35	36	47	45	55	57	70
m2	32	36	45	50	63	71	90
m3	45	52	65	75	95	115	140
m4	31	34	38	38	44	44	66
m5	22	25	28	28	32	32	50
m6	75	82	100	110	147	172	210
∅ n	7	9	9	9	12	14	16
n1	64	72	90	100	126	150	180
n2	32	36	45	50	63	75	90
o	32	32	32	45	45	45	70
∅ p	7	7	9	9	11	11	14
p1	32	36	45	50	63	75	90
p2	24	28	32	32	41	41	45
p3	58	65	82	92	115	132	160
p4	11	12.5	14	14	14	16	25
∅ q	14	14	14	22	22	22	32
s	20	24	24	32	40	40	54
t1	80	90	110	120	150	170	205
t2	45	52	65	75	95	115	140
t3	10	10	12	12	16	16	20

Accessories mounting position related to the limit switches

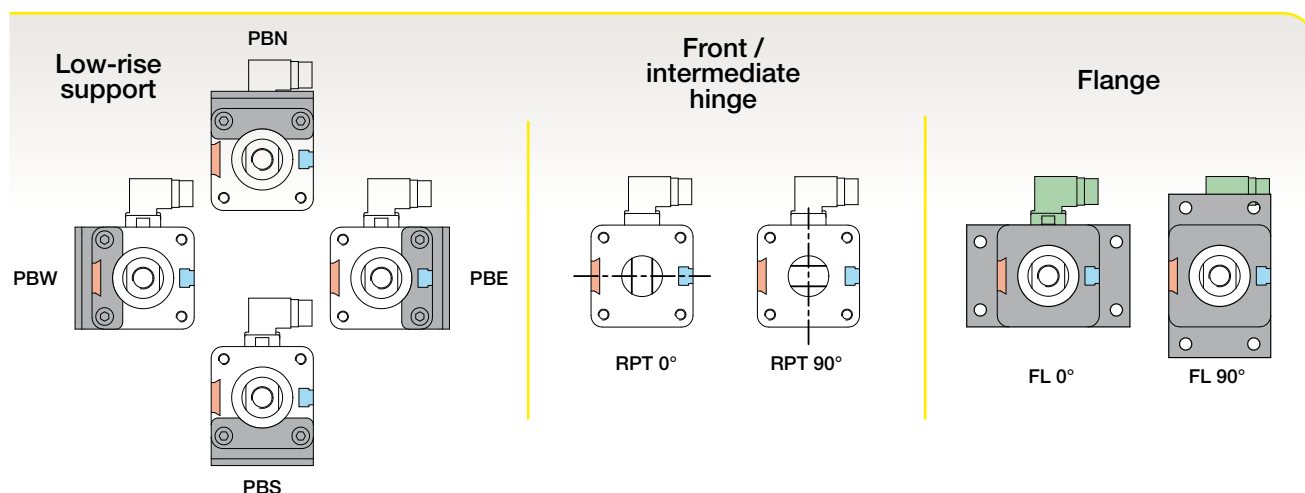

4.4 Performances

Following diagrams show the performances of the standard **actuator + motor** combinations. Values in each diagram refer to a max. ambient temperature of 40°C and a max. altitude of 1000 m ASL.

Three zones can be determined:

- Zone 1:** performances with continuous working cycle
- Zone 2:** performances with working cycle S3 30 % over a 10 min period of time
- Zone 3:** performances that can be reached instantly or during a short period of time

Please refer to tables on pages 20-21 or to Appendix A on page 110 for a correct symbols interpretation. When the working cycle of the actuator requires performances within zone 3 or zone 2 but out of the S3 30 % 10 min limits, you have to verify the suitable motor, as explained in Chapter 6.2 on page 60.

WARNING: the following performance diagrams refer to the max motor torque. A possible performance degrading shall occur depending on drive model type, as specified in Chapter 12.8 on pages 102-103.

4.4.1 SA 0 IL

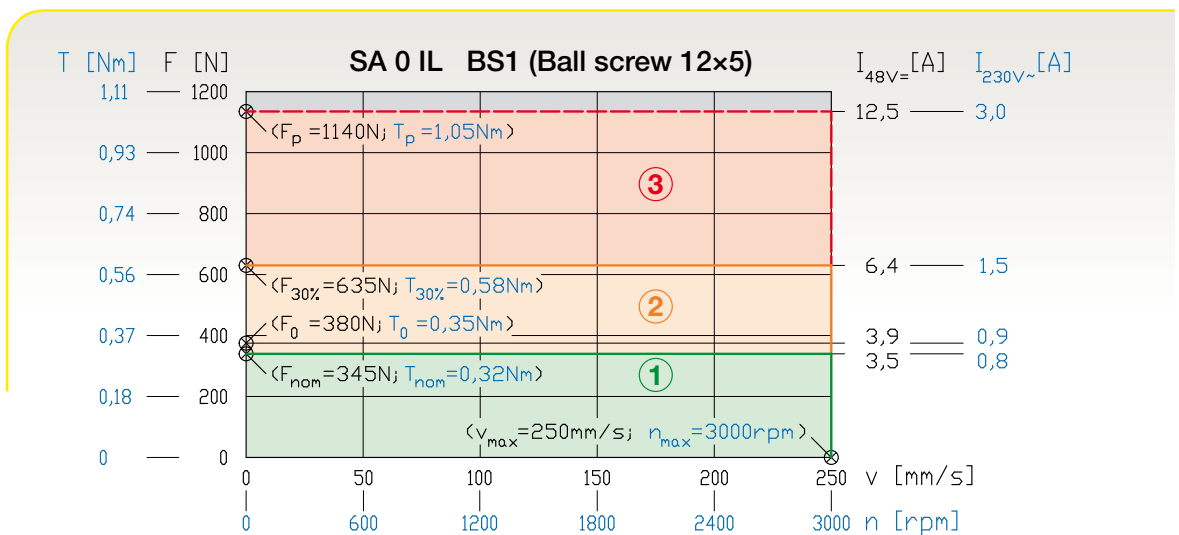

4.4.1 SA 0 IL

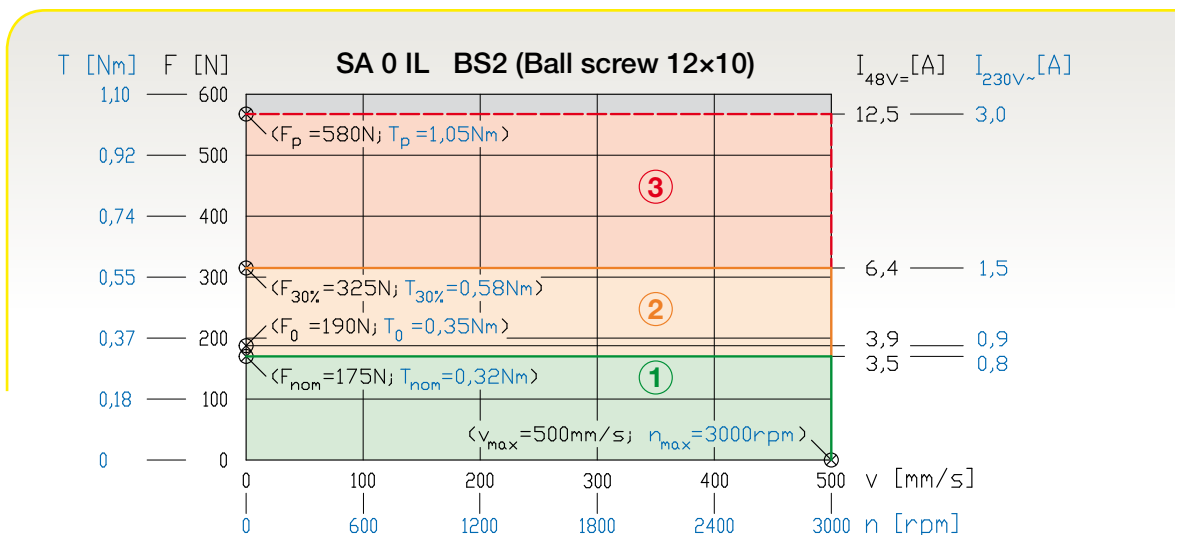

4.4 Performances

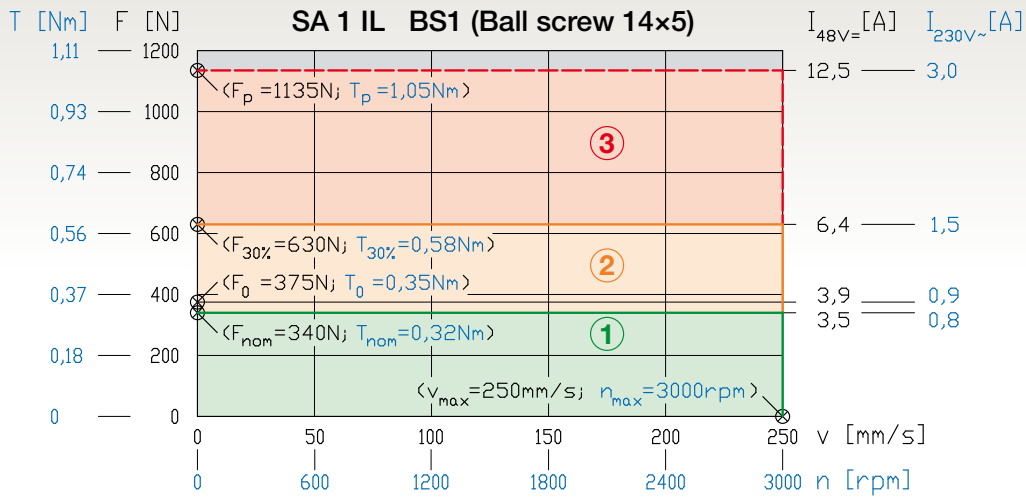

4.4.2 SA 1 IL

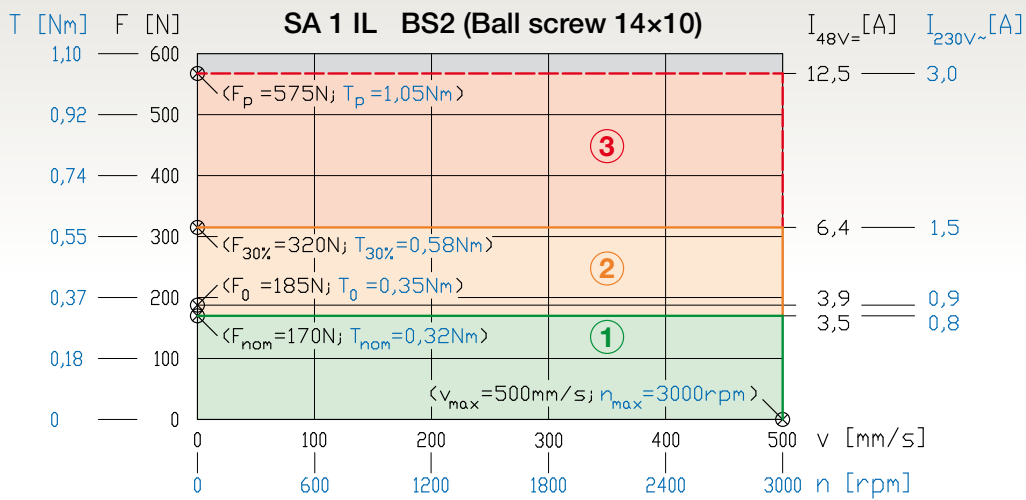

4.4.2 SA 1 IL

4.4 Performances

4.4.3 SA 2 IL

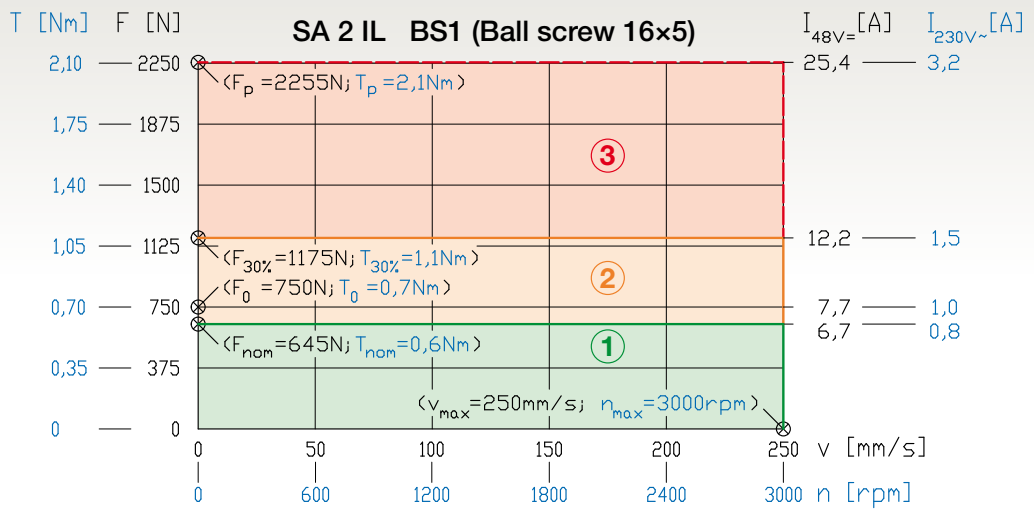

4.4.3 SA 2 IL

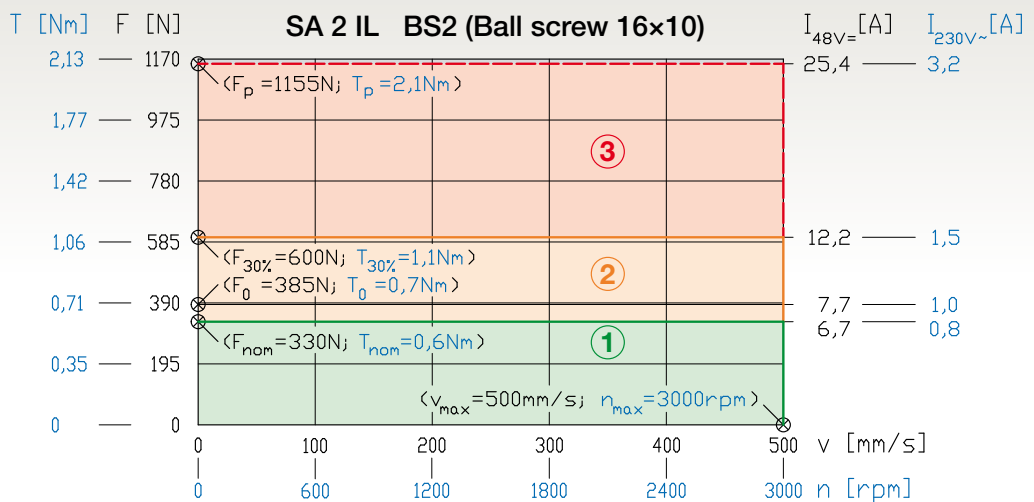

4.4.3 SA 2 IL

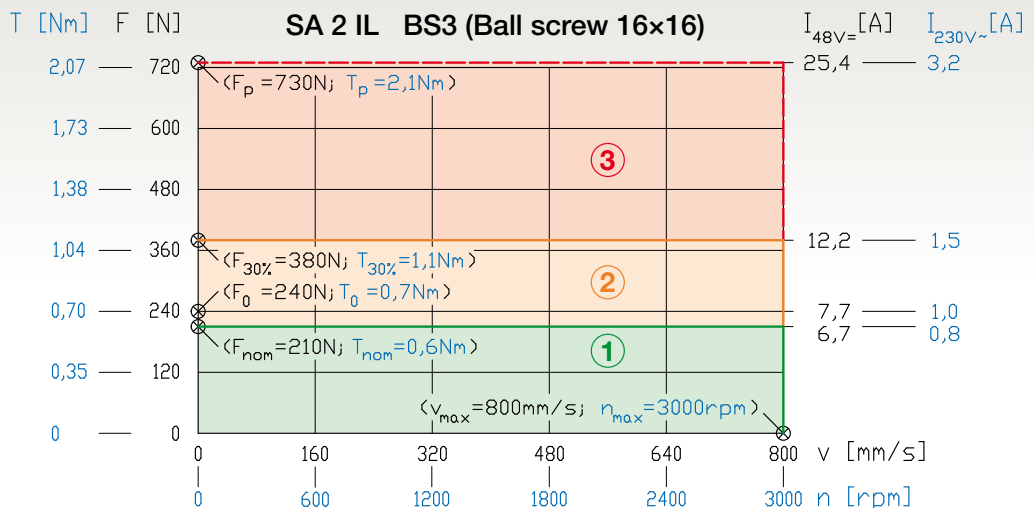

4. SA IL Series Servoactuators



WARNING: the following performance diagrams refer to the motor maximum torque. A possible performance degrading shall occur depending on drive model type, as specified in Chapter 12.8 on pages 102-103.

4.4.4 SA 3 IL

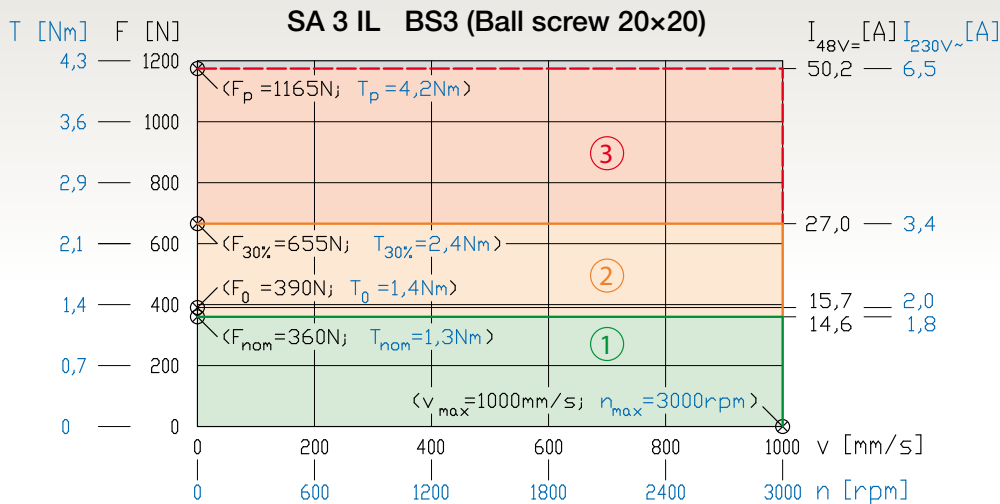
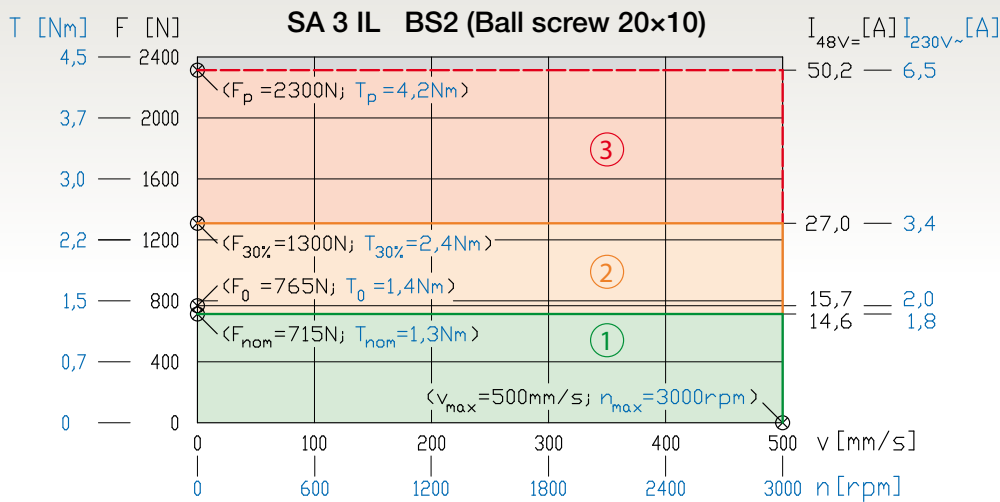
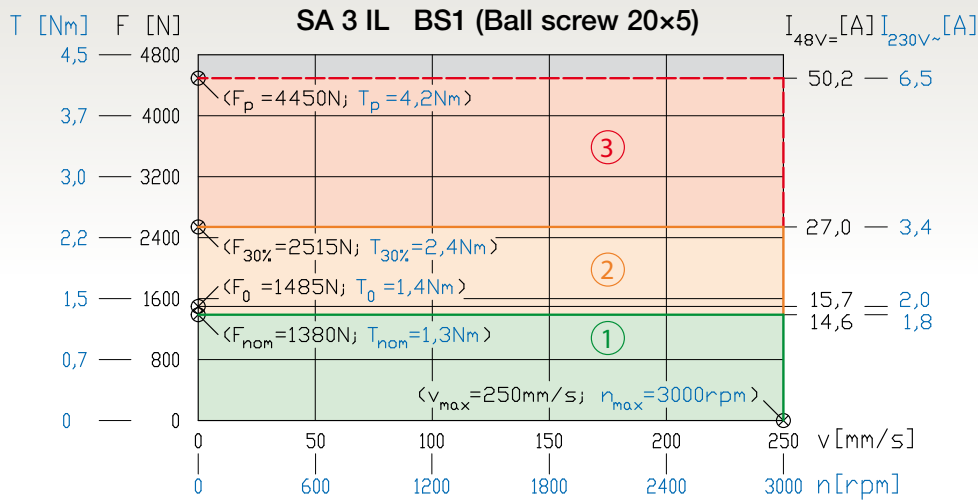

4.4.4 SA 3 IL

4.4.4 SA 3 IL

4.4 Performances

4.4.5 SA 4 IL

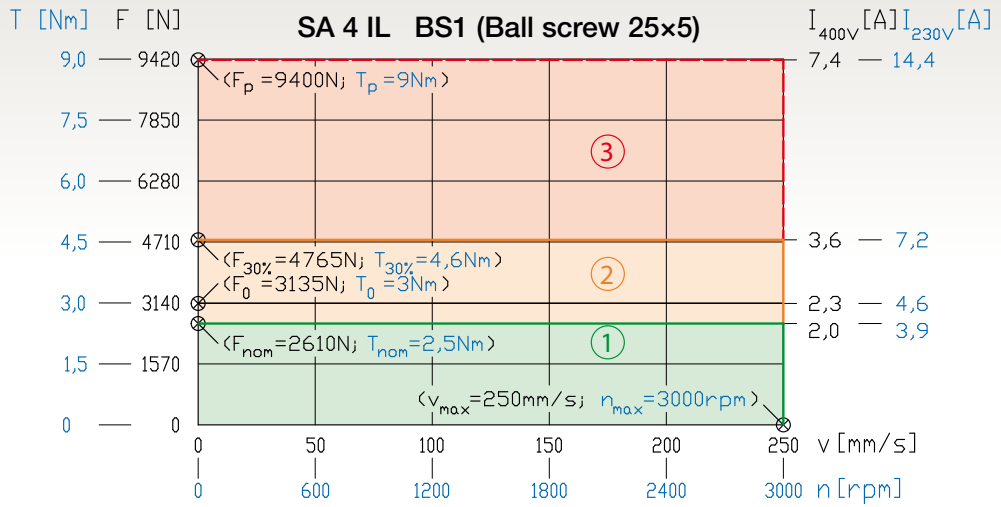

4.4.5 SA 4 IL

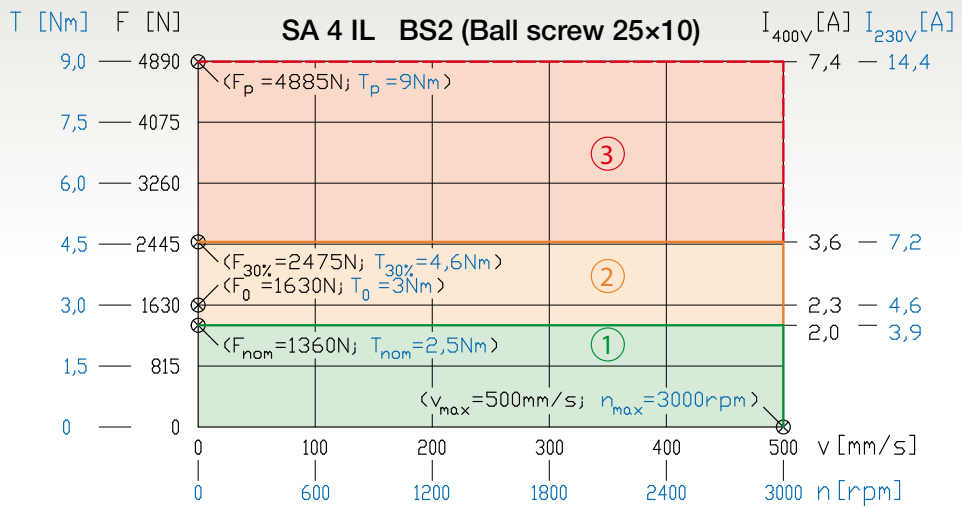

4. SA IL Series Servoactuators



WARNING: the following performance diagrams refer to the motor maximum torque. A possible performance degrading shall occur depending on drive model type, as specified in Chapter 12.8 on pages 102-103.

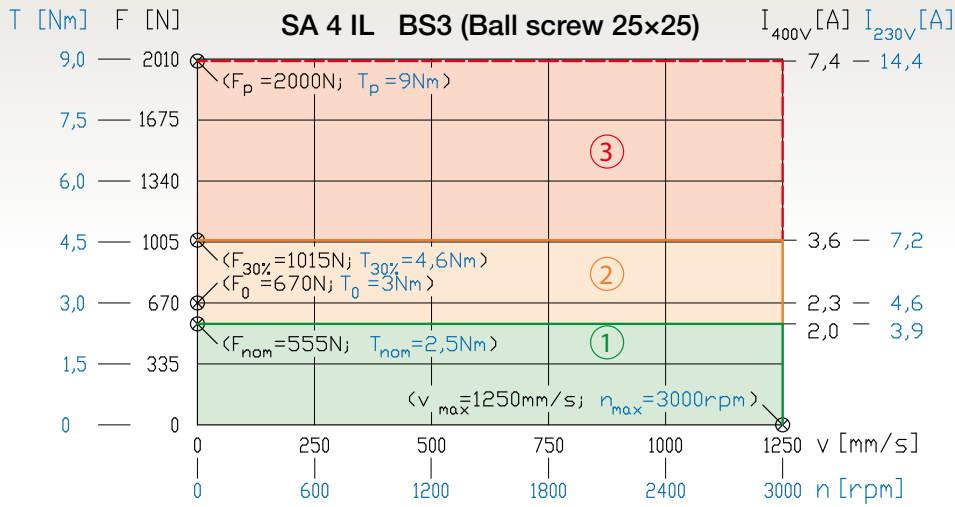

4.4.5 SA 4 IL

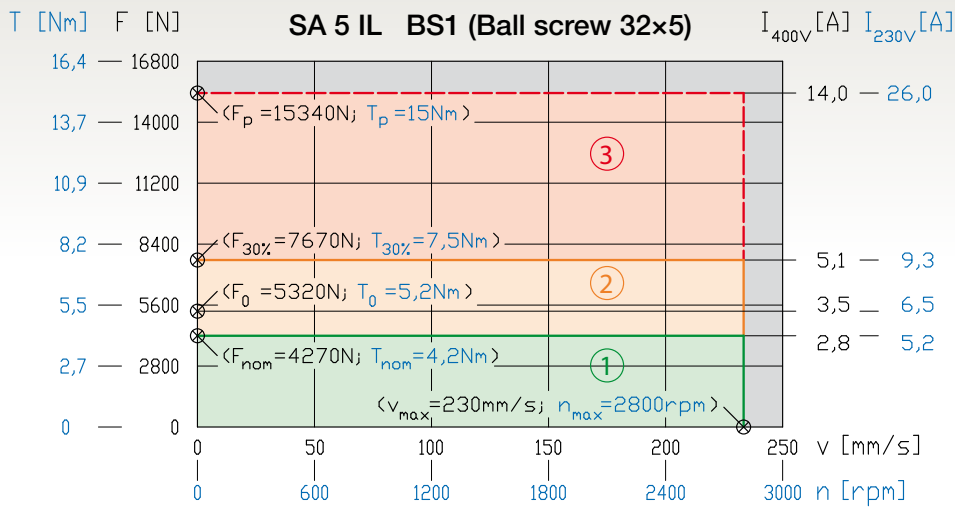

4.4.6 SA 5 IL

4.4 Performances

4.4.6 SA 5 IL

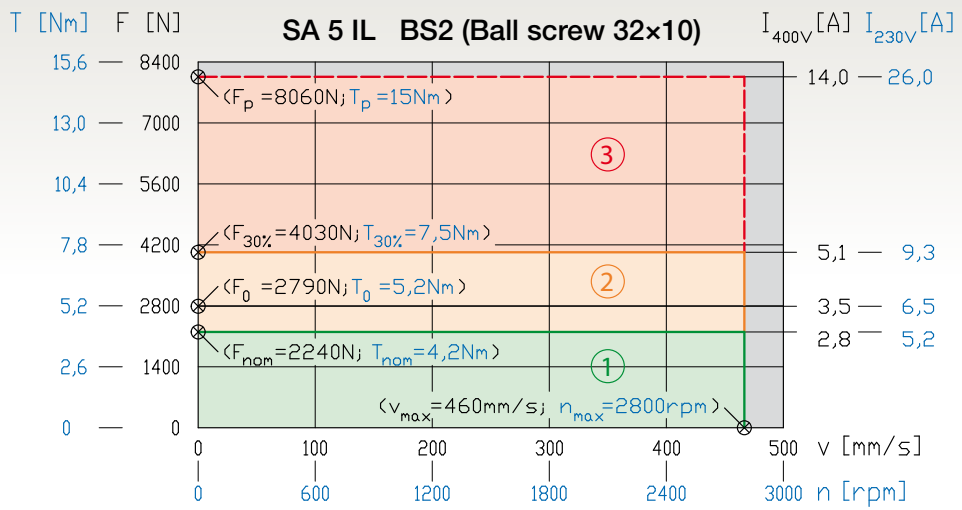

4.4.6 SA 5 IL

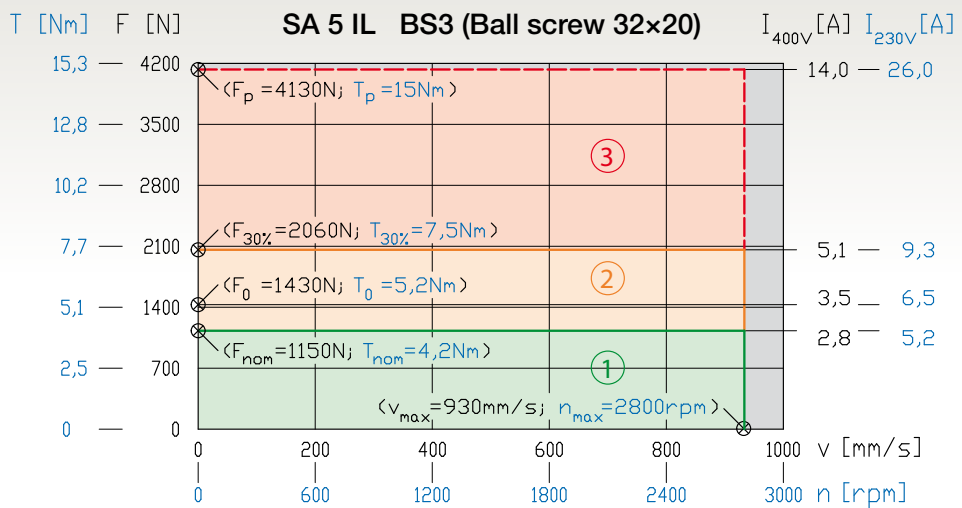

4.4.6 SA 5 IL

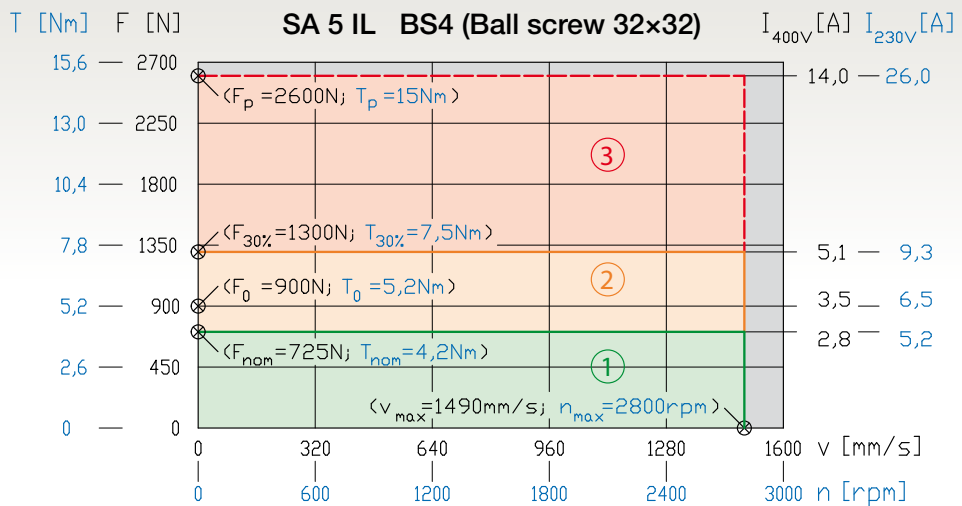

4. SA IL Series Servoactuators



WARNING: the following performance diagrams refer to the motor maximum torque. A possible performance degrading shall occur depending on drive model type, as specified in Chapter 12.8 on pages 102-103.

4.4.7 SA 6 IL

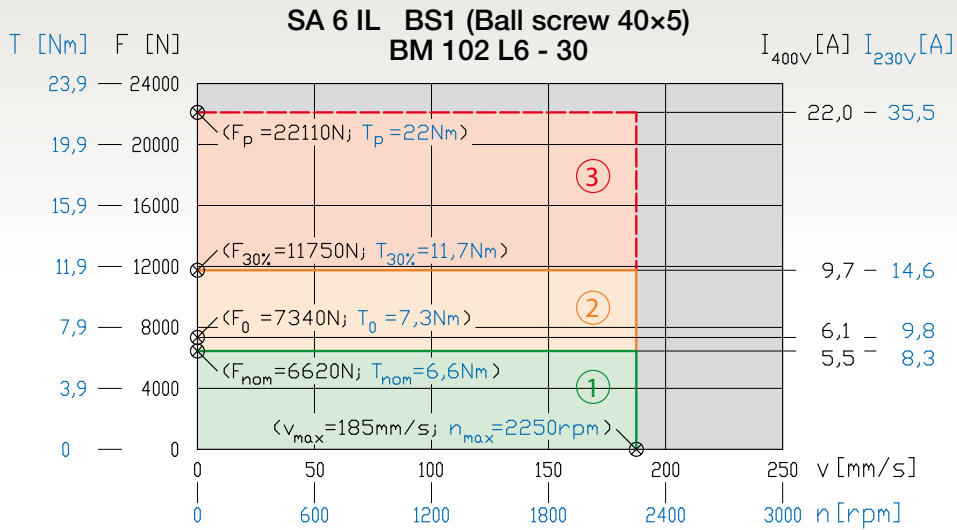

4.4.7 SA 6 IL

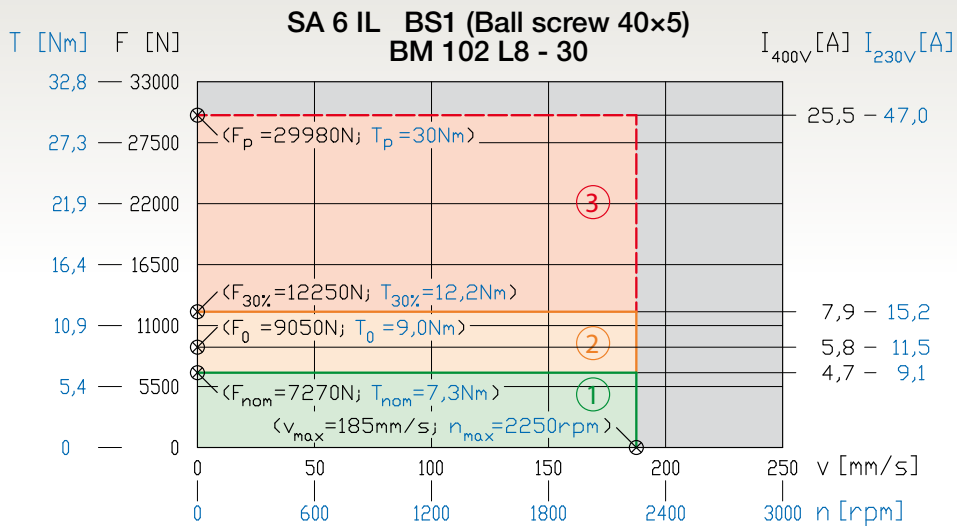

4.4.7 SA 6 IL

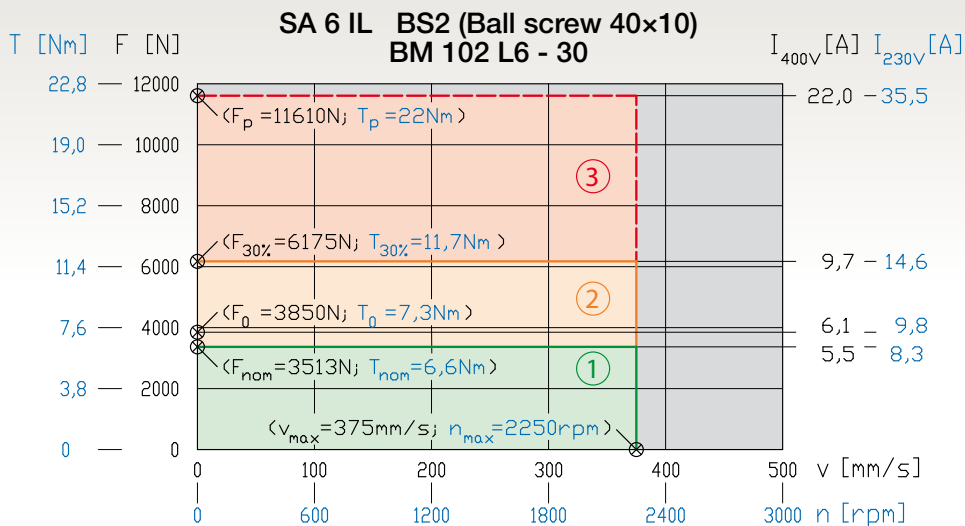

4.4 Performances

4.4.7 SA 6 IL

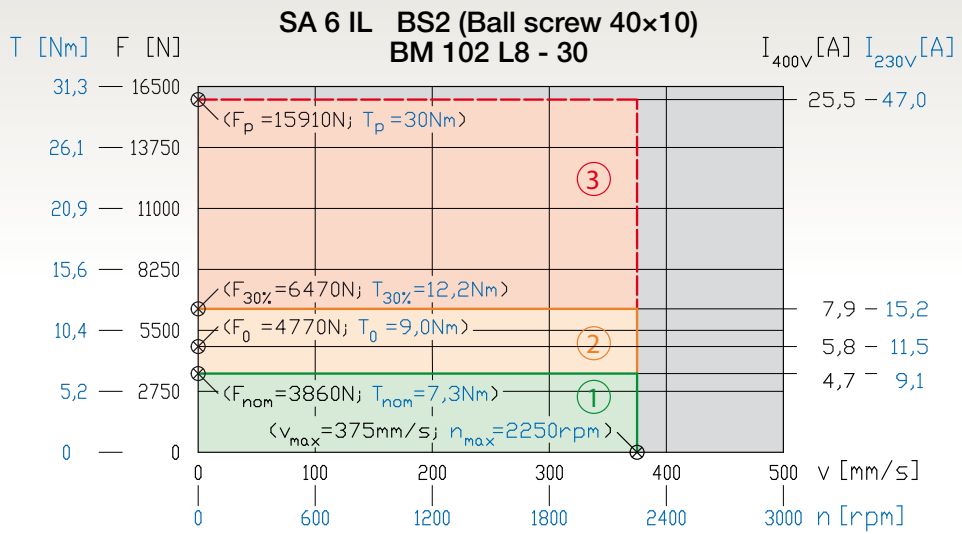

4.4.7 SA 6 IL

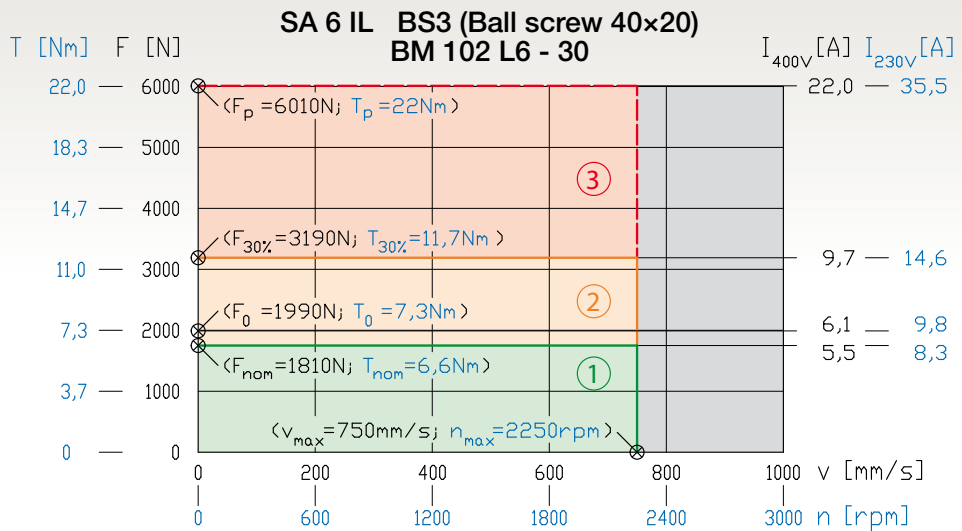

4.4.7 SA 6 IL

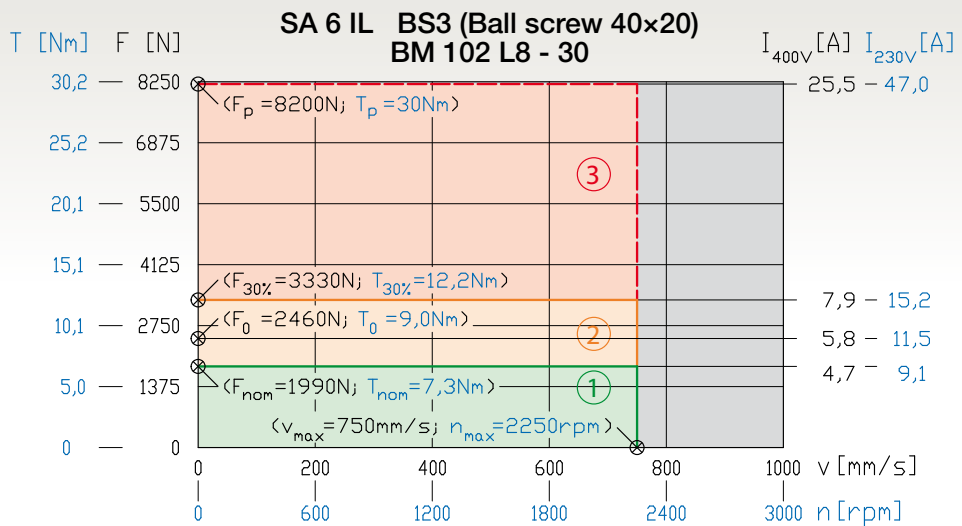

4. SA IL Series Servoactuators



WARNING: the following performance diagrams refer to the motor maximum torque. A possible performance degrading shall occur depending on drive model type, as specified in Chapter 12.8 on pages 102-103.

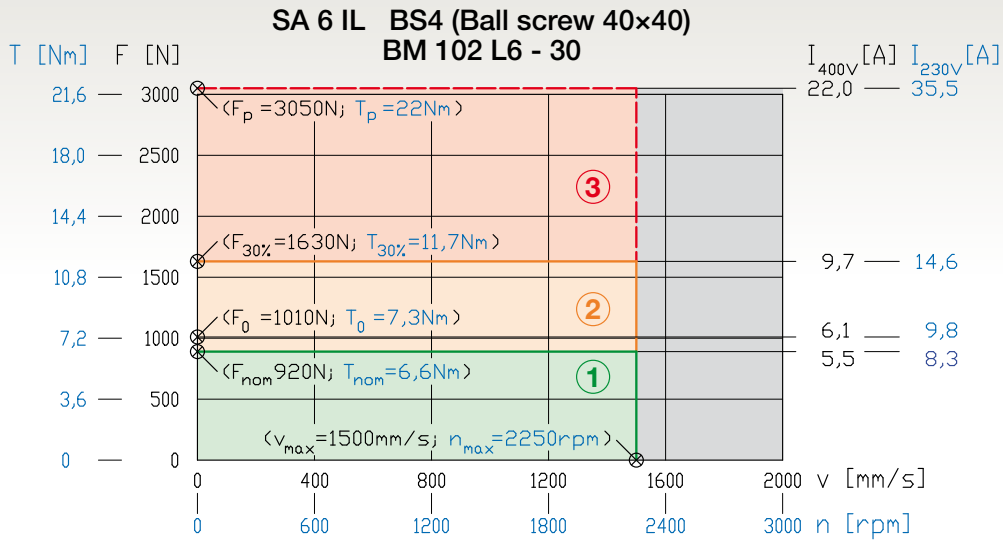

4.4.7 SA 6 IL

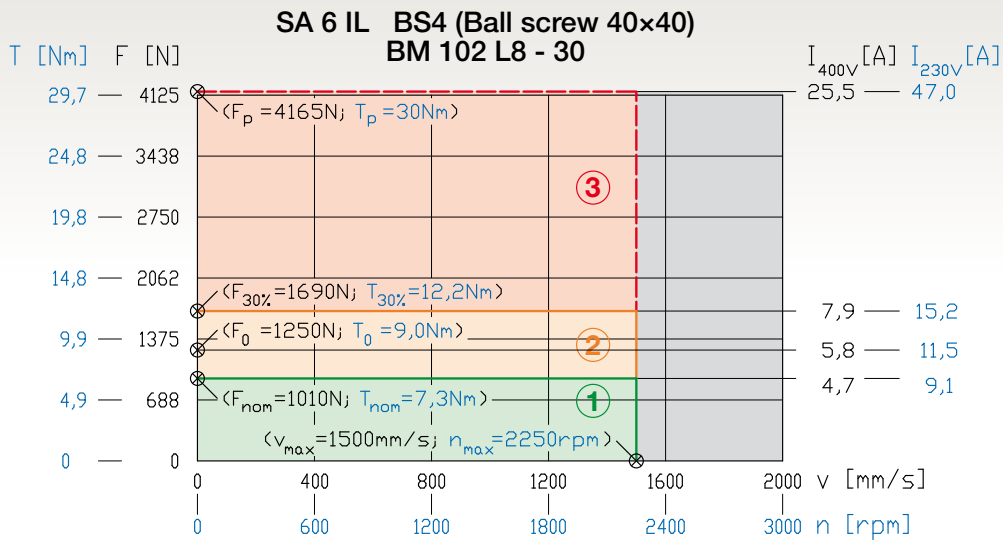

4.4.7 SA 6 IL

5.1 Technical Data

SIZE		SA 0 PD		SA 1 PD		SA 2 PD			SA 3 PD				
Profile ISO 15552	[mm]	□ 45		□ 52		□ 65			□ 75				
Rod diameter	[mm]	∅ 20		∅ 22		∅ 25			∅ 30				
Front attachment thread	[mm]	M10 × 1.25 depth 15 mm		M12 × 1.25 depth 20 mm		M12 × 1.25 depth 20 mm			M16 × 1.5 depth 24 mm				
Ball screw BS		BS1	BS2	BS1	BS2	BS1	BS2	BS3	BS1	BS2	BS3		
Diameter × Lead ($d_o \times P_h$)	[mm]	12 × 5	12 × 10	14 × 5	14 × 10	16 × 5	16 × 10	16 × 16	20 × 5	20 × 10	20 × 20		
Ball (D_w)	[mm]	∅ 2.381		∅ 3.175		∅ 3.175			∅ 3.175				
Accuracy grade (1)		IT 7		IT 7		IT 7			IT 7				
N° of circuits		3	2	3	2	4	3	2	4	3	2		
N° of starts		1	2	1	1	1	1	2	1	1	2		
Dynamic load (C_d)	[N]	5300	6600	7800	5300	11100	8900	10500	12800	10200	12100		
Static load (C_{da})	[N]	8000	9500	11100	6900	18100	14400	15700	24400	18900	20900		
Brushless servomotor		BM 45 L - 30		BM 45 L - 30		BM 63 S - 30			BM 63 L - 30				
Peak torque T_p (2)	[Nm]	1.05		1.05		2.1			4.2				
Stall torque $T_{0,100k}$	[Nm]	0.35		0.35		0.7			1.4				
Rated torque $T_{nom,100k}$	[Nm]	0.32		0.32		0.6			1.3				
Nominal speed n_{nom}	[rpm]	3000		3000		3000			3000				
Ratio (u) RV		1 : 1 (16 : 16)		1 : 1 (21 : 21)		1 : 1 (26 : 26)			1 : 1.06 (32 : 34)				
Linear travel for 1 motor shaft revolution	[mm]	5	10	5	10	5	10	16	4.706	9.412	18.824		
Peak load F_p (2)	[N]	1080	550	1075	545	2140	1095	690	4490	2315	1175		
Continuous load at zero-speed F_0	[N]	360	180	355	175	710	365	230	1495	770	390		
Continuous load at no-zero-speed F_{nom}	[N]	330	165	325	160	610	310	195	1390	715	360		
Max. linear speed v_{max}	[mm/s]	250	500	250	500	250	500	800	235	470	940		
Total actuator efficiency (η)		0.82	0.83	0.81	0.83	0.81	0.83	0.84	0.79	0.82	0.84		
Ratio (u) RN		-		-		-			1 : 1.27 (30 : 38)				
Linear travel for 1 motor shaft revolution	[mm]	-		-		-			3.947	7.895	15.789		
Peak load F_p (2)	[N]	-		-		-			5360	2760	1400		
Continuous load at zero-speed F_0	[N]	-		-		-			1790	920	465		
Continuous load at no-zero-speed F_{nom}	[N]	-		-		-			1660	855	430		
Max. linear speed v_{max}	[mm/s]	-		-		-			195	390	780		
Total actuator efficiency (η)		-		-		-			0.80	0.83	0.84		
Mass in linear motion (m) and moment of inertia (J) of the actuator reduced to motor shaft													
m_0 ref. to 0 mm stroke	[kg]	0.32	0.32	0.47	0.48	0.61	0.62	0.61	1.00	1.01	1.00		
m_{100} ref. to each 100 mm extra-stroke	[kg]	0.13		0.14		0.19			0.20				
J_0 ref. to 0 mm stroke actuator	RV	without brake	[kg×m ²]	1.4×10 ⁻⁵	1.5×10 ⁻⁵	1.7×10 ⁻⁵	1.8×10 ⁻⁵	3.6×10 ⁻⁵	3.7×10 ⁻⁵	4.0×10 ⁻⁵	7.2×10 ⁻⁵	7.4×10 ⁻⁵	8.2×10 ⁻⁵
		with brake	[kg×m ²]	1.4×10 ⁻⁵	1.5×10 ⁻⁵	1.7×10 ⁻⁵	1.8×10 ⁻⁵	3.8×10 ⁻⁵	3.9×10 ⁻⁵	4.2×10 ⁻⁵	7.4×10 ⁻⁵	7.6×10 ⁻⁵	8.4×10 ⁻⁵
	RN	without brake	[kg×m ²]	-	-	-	-	-	-	-	6.1×10 ⁻⁵	6.2×10 ⁻⁵	6.8×10 ⁻⁵
		with brake	[kg×m ²]	-	-	-	-	-	-	-	6.3×10 ⁻⁵	6.4×10 ⁻⁵	7.0×10 ⁻⁵
J_{100} for each 100 mm extra-stroke	RV	[kg×m ²]	1.9×10 ⁻⁶	2.1×10 ⁻⁶	2.7×10 ⁻⁶	3.0×10 ⁻⁶	4.7×10 ⁻⁶	5.1×10 ⁻⁶	6.0×10 ⁻⁶	1.0×10 ⁻⁵	1.1×10 ⁻⁵	1.2×10 ⁻⁵	
	RN	[kg×m ²]	-	-	-	-	-	-	-	7.3×10 ⁻⁶	7.6×10 ⁻⁶	8.7×10 ⁻⁶	
Weight of 100 mm stroke actuator (3)	[kg]	3.0 (3.3)		3.5 (3.8)		5.2 (5.9)			7.4 (8.1)				
Weight for each 100 mm extra-stroke	[kg]	0.44		0.51		0.67			0.79				
Operating temperature	[°C]	10 ... 40											

(1) - ball screws with accuracy grade IT 3 or IT 5 available on request

(2) - valid only in case of intermittent working

(3) - weight of actuator without accessories

5.1 Technical Data

SA 4 PD			SA 5 PD				SA 6 PD				SIZE
□ 95			□ 115				□ 140				[mm] Profile ISO 15552
∅ 35			∅ 50				∅ 60				[mm] Rod diameter
M20 × 1.5 depth 30 mm			M20 × 1.5 depth 40 mm				M27 × 2 depth 54 mm				[mm] Front attachment thread
BS1	BS2	BS3	BS1	BS2	BS3	BS4	BS1	BS2	BS3	BS4	Ball screw BS
25 × 5	25 × 10	25 × 25	32 × 5	32 × 10	32 × 20	32 × 32	40 × 5	40 × 10	40 × 20	40 × 40	[mm] Diameter × Lead ($d_o \times P_h$)
∅ 3.175	∅ 3.969	∅ 3.175	∅ 3.175	∅ 6.350	∅ 6.350	∅ 6.350	∅ 3.175	∅ 6.350	∅ 6.350	∅ 6.350	[mm] Ball (D_w)
IT 7			IT 7				IT 7				Accuracy grade (1)
4	3	2	6	4	3	2	6	4	3	2	N° of circuits
1	1	2	1	1	1	2	1	1	1	2	N° of starts
14500	14800	13600	23000	37000	29800	35000	25300	42800	34300	40300	[N] Dynamic load C_a
31500	28000	27300	60200	66800	53200	58100	76900	88900	70000	77100	[N] Static load C_{0a}
BM 82 L - 30			BM 102 S - 30				BM 102 L6 - 30 BM 102 L8 - 30				Brushless servomotor
9			15				22 30				[Nm] Peak torque T_p (2)
3			5.2				7.3 9				[Nm] Stall torque $T_{0,100K}$
2.5			4.1				6.4 6.7				[Nm] Rated torque $T_{nom,100K}$
3000			3000				3000				[rpm] Nominal speed n_{nom}
1 : 1.09 (44 : 48)			1 : 1 (36 : 36)				1 : 1 (40 : 40)				Ratio (u) RV
4,583	9,167	22,917	5	10	20	32	5	10	20	40	[mm] Linear travel for 1 motor shaft revolution
9740	5050	2070	14580	7650	3920	2470	20885 28480	11085 15115	5715 7795	2900 3955	[N] Peak load F_p (2)
3240	1680	690	5050	2650	1360	860	6930 8545	3680 4535	1895 2340	960 1185	[N] Continuous load at zero-speed F_0
2700	1400	575	4055	2130	1090	690	6290 6905	3335 3665	1720 1890	875 960	[N] Continuous load at no-zero-speed F_{nom}
230	450	1140	230	460	930	1490	185	375	750	1500	[mm/s] Max. linear speed v_{max}
0.78	0.82	0.84	0.76	0.81	0.83	0.84	0.74	0.79	0.82	0.84	Total actuator efficiency (η)
1 : 1.33 (36 : 48)			1 : 1.47 (30 : 44)				1 : 1.5 (32 : 48)				Ratio (u) RN
3.75	7.5	18.75	3.409	6.818	13.636	21.818	3.334	6.667	13.334	26.667	[mm] Linear travel for 1 motor shaft revolution
11900	6190	2530	21380	11220	5750	3625	31324 42715	16625 22670	8575 11690	4355 5935	[N] Peak load F_p (2)
3970	2060	845	7410	3890	1995	1255	10395 12815	5515 6800	2845 3505	1445 1780	[N] Continuous load at zero-speed F_0
3300	1720	700	5845	3070	1570	990	9130 9540	4840 5060	2495 2611	1265 1325	[N] Continuous load at no-zero-speed F_{nom}
190	375	935	170	340	680	1090	167	333	667	1333	[mm/s] Max. linear speed v_{max}
0.79	0.82	0.84	0.77	0.81	0.83	0.84	0.76	0.80	0.83	0.84	Total actuator efficiency (η)
Mass in linear motion (m) and moment of inertia (J) of the actuator reduced to motor shaft											
1.45	1.44	1.46	3.37	3.22	3.26	3.19	4.90	4.90	4.90	4.90	[kg] m_0 ref. to 0 mm stroke
0.24			0.49				0.62				[kg] m_{100} ref. to each 100 mm extra-stroke
2.3×10^{-4}	2.4×10^{-4}	2.5×10^{-4}	7.8×10^{-4}	7.9×10^{-4}	8.1×10^{-4}	8.7×10^{-4}	1.7×10^{-3}	1.7×10^{-3}	1.7×10^{-3}	1.9×10^{-3}	[kg·m ²] without brake
2.5×10^{-4}	2.5×10^{-4}	2.7×10^{-4}	8.2×10^{-4}	8.3×10^{-4}	8.6×10^{-4}	9.2×10^{-4}	1.7×10^{-3}	1.7×10^{-3}	1.8×10^{-3}	2.0×10^{-3}	[kg·m ²] with brake
1.9×10^{-4}	1.9×10^{-4}	2.0×10^{-4}	5.3×10^{-4}	5.4×10^{-4}	5.5×10^{-4}	5.8×10^{-4}	1.0×10^{-3}	1.0×10^{-3}	1.1×10^{-3}	1.1×10^{-3}	[kg·m ²] without brake
2.0×10^{-4}	2.0×10^{-4}	2.1×10^{-4}	5.8×10^{-4}	5.8×10^{-4}	6.0×10^{-4}	6.2×10^{-4}	1.1×10^{-3}	1.1×10^{-3}	1.1×10^{-3}	1.2×10^{-3}	[kg·m ²] with brake
2.4×10^{-5}	2.4×10^{-5}	2.8×10^{-5}	7.3×10^{-5}	7.4×10^{-5}	7.9×10^{-5}	8.8×10^{-5}	1.9×10^{-4}	1.9×10^{-4}	1.9×10^{-4}	2.2×10^{-4}	[kg·m ²] RV
1.6×10^{-5}	1.6×10^{-5}	1.8×10^{-5}	3.4×10^{-5}	3.4×10^{-5}	3.7×10^{-5}	4.1×10^{-5}	8.3×10^{-5}	8.4×10^{-5}	8.7×10^{-5}	9.6×10^{-5}	[kg·m ²] RN
13 (15)			24 (26)				39 (41)				[kg] Weight of 100 mm stroke actuator (3)
1.1			1.9				2.7				[kg] Weight for each 100 mm extra-stroke
10 ... 40											[°C] Operating temperature

(1) - ball screws with accuracy grade IT 3 or IT 5 available on request
 (2) - valid only in case of intermittent working
 (3) - weight of actuator without accessories

5.2 Dimensions

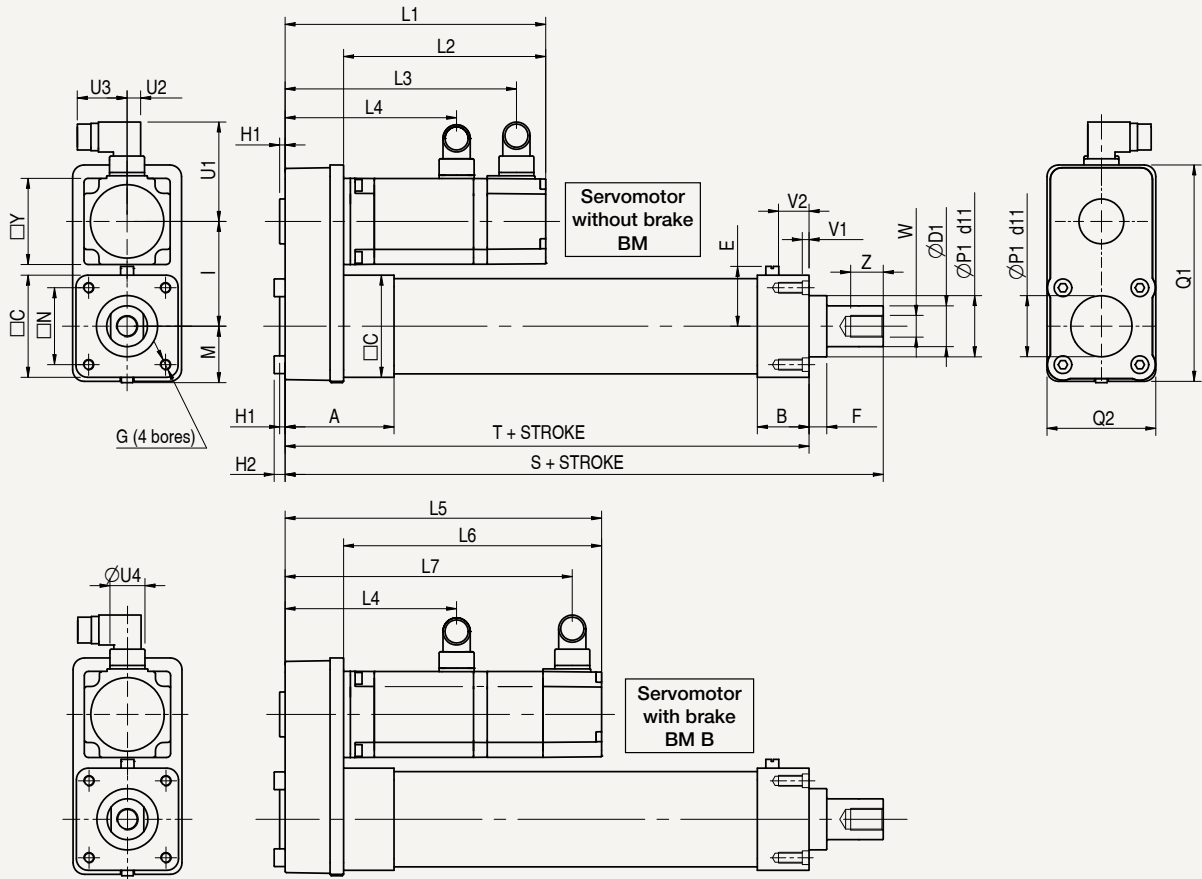

Servomotor mounting positions

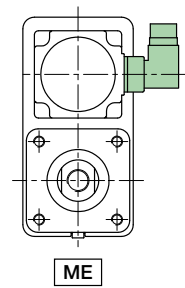
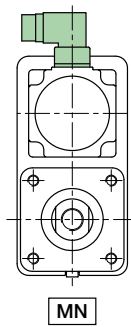
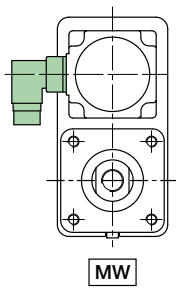

Stroke end switch slot positions

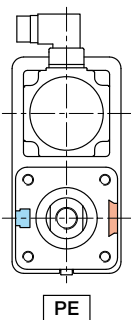
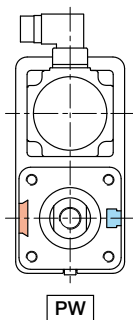

5.2 Dimensions

SIZE	SA 0 PD	SA 1 PD	SA 2 PD	SA 3 PD	SA 4 PD	SA 5 PD	SA 6 PD
A	65	65	80	80	104	165	207
B	40	34	40	38	51.5	82	108
□ C	46	52	65	75	95	112	138
∅ D1	20	22	25	30	35	50	60
E	30	32	39	44	54	-	-
F	21.5	10	13	13	5	8	8
G	M6	M6	M8	M8	M10	M10	M12
H1	4	4	4	4	4	4	5
H2	6	6	8	8	10	10	12
I	52	56	71	79	102	123.5	132.5
L1	159	159	167	192	216	245.5	317.5
L2	123	123	124	149	160	177	227
L3	137.5	137.5	144.5	170	194	223	295
L4	92.5	92.5	100.5	125	150	173.5	245.5
L5	196	196	212	237	278	299.5	371.5
L6	156	156	165	190	218	231	281
L7	171	171	185.5	211	252	277	349
M	27	30	37	43.5	52.5	65.5	79.5
□ N	32.5	38	46.5	56.5	72	89	110
∅ P1	30	35	40	45	45	70	80
Q1	101	108	138	160	199	239	261
Q2	50	60	70	80	100	120	150
S	264	281	307	339.5	388.5	522	629
T	237.5	240.5	260.5	285	340.5	464	564
U1	66	66	73	73	85	94.5	94.5
U2	10	10	10	10	14	14	14
U3	36.5	36.5	36.5	36.5	41	41	41
∅ U4	26	26	26	26	28	28	28
V1	4.5	4.5	5.5	5.5	5.5	25	30
V2	17.5	17.5	22.5	22.5	27.5	-	-
W	M10 × 1.25	M12 × 1.25	M12 × 1.25	M16 × 1.5	M20 × 1.5	M20 × 1.5	M27 × 2
□ Y	45	45	63	63	82	102	102
Z	15	20	20	24	30	40	54

Standard stroke lengths:

Stroke [mm]	100	200	300	400	500	600	700	800	900	1000
SA 0 PD	C100	C200	C300	-	-	-	-	-	-	-
SA 1 PD	C100	C200	C300	C400	-	-	-	-	-	-
SA 2 PD	C100	C200	C300	C400	C500	C600	-	-	-	-
SA 3 PD	C100	C200	C300	C400	C500	C600	C700	C800	-	-
SA 4 PD	C100	C200	C300	C400	C500	C600	C700	C800	-	-
SA 5 PD	C100	C200	C300	C400	C500	C600	C700	C800	C900	C1000
SA 6 PD	C100	C200	C300	C400	C500	C600	C700	C800	C900	C1000

5.3 Accessories Dimensions

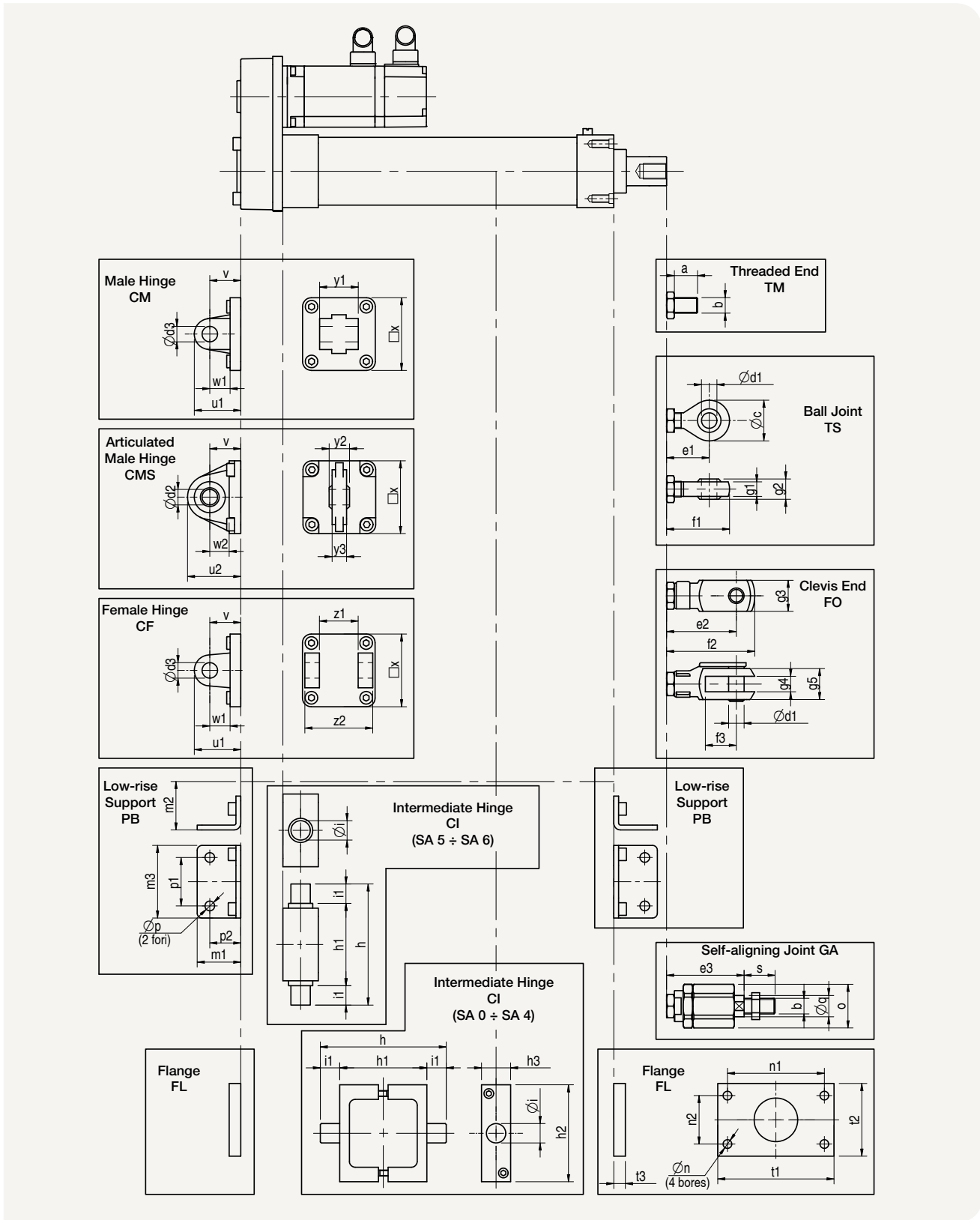

NOTE: Front attachments TS and FO must be aligned during assembling with the rear hinge axis; avoid any torsional load on the shaft to prevent damages on the anti-rotation device.

5.3 Accessories Dimensions

SIZE	SA 0 PD	SA 1 PD	SA 2 PD	SA 3 PD	SA 4 PD	SA 5 PD	SA 6 PD
a	15	20	20	24	30	40	54
b	M10 × 1.25	M12 × 1.25	M12 × 1.25	M16 × 1.5	M20 × 1.5	M20 × 1.5	M27 × 2
∅ c	28	32	32	42	50	50	70
∅ d1	10	12	12	16	20	20	30
∅ d2	10	12	16	16	20	20	30
∅ d3	10	12	12	16	16	20	25
e1	35	36	36	44	50	50	125
e2	46	55	55	72	89	89	122
e3	57.5	58.5	58.5	80	88	88	105
f1	49	52	52	65	75	75	160
f2	58	69	69	91	114	114	160
f3	20	24	24	32	40	40	54
g1	10.5	12	12	15	18	18	25
g2	14	16	16	21	25	25	37
g3	20	24	24	32	40	40	55
g4	10	12	12	16	20	20	30
g5	20	24	24	32	40	40	55
h	74	95	105	130	148	182	210
h1	50	63	73	90	108	132	160
h2	74	80	90	100	130	-	-
h3	25	25	25	30	30	-	-
∅ i	12	16	16	20	20	25	25
i1	12	16	16	20	20	25	25
m1	35	36	47	45	55	57	70
m2	32	36	45	50	63	71	90
m3	45	52	65	75	95	115	140
∅ n	7	9	9	9	12	14	16
n1	64	72	90	100	126	150	180
n2	32	36	45	50	63	75	90
o	32	32	32	45	45	45	70
∅ p	7	7	9	9	11	11	14
p1	32	36	45	50	63	75	90
p2	24	28	32	32	41	41	45
∅ q	14	14	14	22	22	22	32
s	20	24	24	32	40	40	54
t1	80	90	110	120	150	170	205
t2	45	52	65	75	95	115	140
t3	10	10	12	12	16	16	20
u1	32	37	39	48	52	61	75
u2	38	43	48	55	64	71	90
v	22	25	27	32	36	41	50
w1	13	16	16	21	22	27	30
w2	12	15	15	20	20	25	30
□ x	45	52	65	75	95	115	140
y1	26	28	32	40	50	60	70
y2	14	16	21	21	25	25	37
y3	10.5	12	15	15	18	18	25
z1	26	28	32	40	50	60	70
z2	45	52	60	70	90	110	130

Accessories mounting position

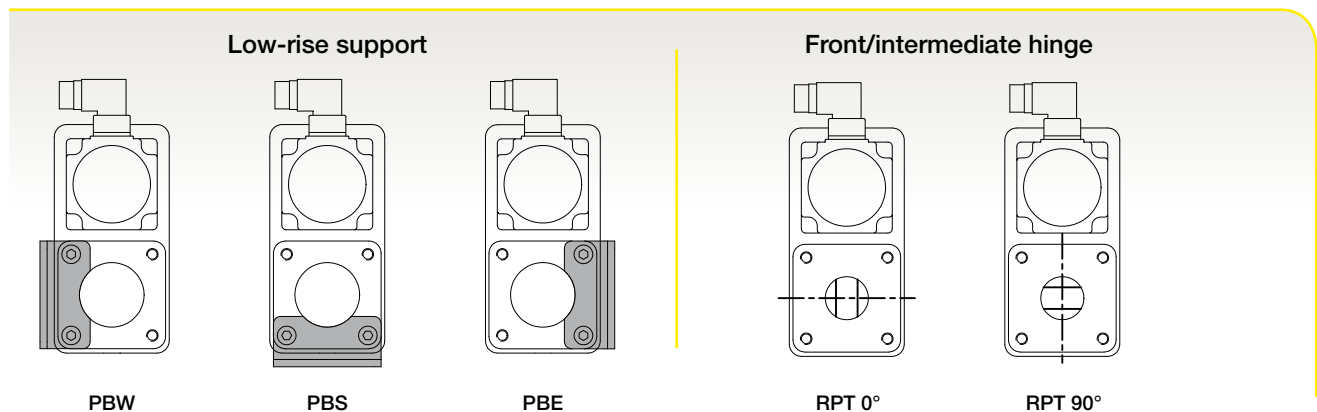

5.4 Performances

Following diagrams show the performances of the standard **actuator + motor** combinations. Values in each diagram refer to a max. ambient temperature of 40°C and a max. altitude of 1000 m ASL.

Three zones can be determined:

Zone 1: performances with continuous working cycle

Zone 2: performances with working cycle S3 30 % over a 10 min period of time

Zone 3: performances that can be reached instantly or during a short period of time

Please refer to tables on pages 20-21 or to Appendix A on page 110 for a correct symbols interpretation. When the working cycle of the actuator requires performances within zone 3 or zone 2 but out of the S3 30 % 10 min limits, you have to verify the suitable motor, as explained in Chapter 6.2 on page 60.

WARNING: the following performance diagrams refer to the max motor torque. A possible performance degrading shall occur depending on drive model type, as specified in Chapter 12.8 on pages 102-103.

5.4.1 SA 0 PD

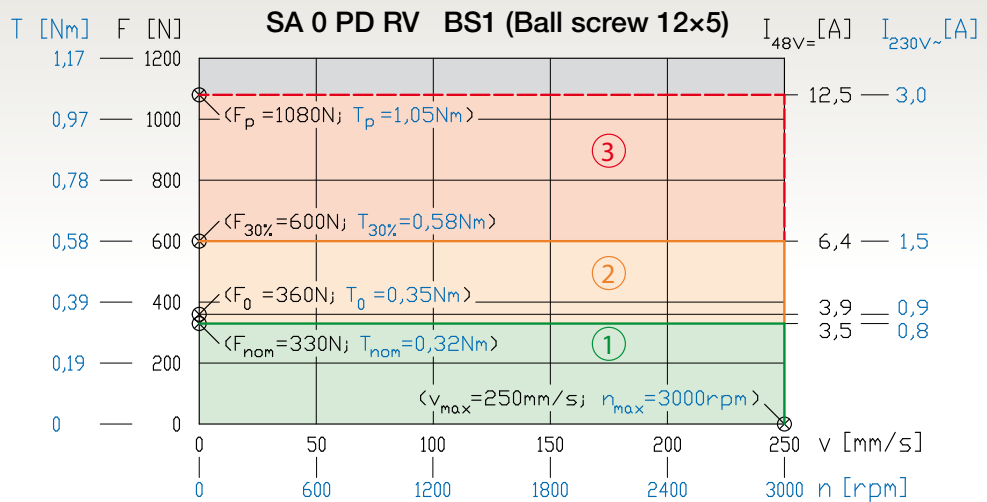

5.4.1 SA 0 PD

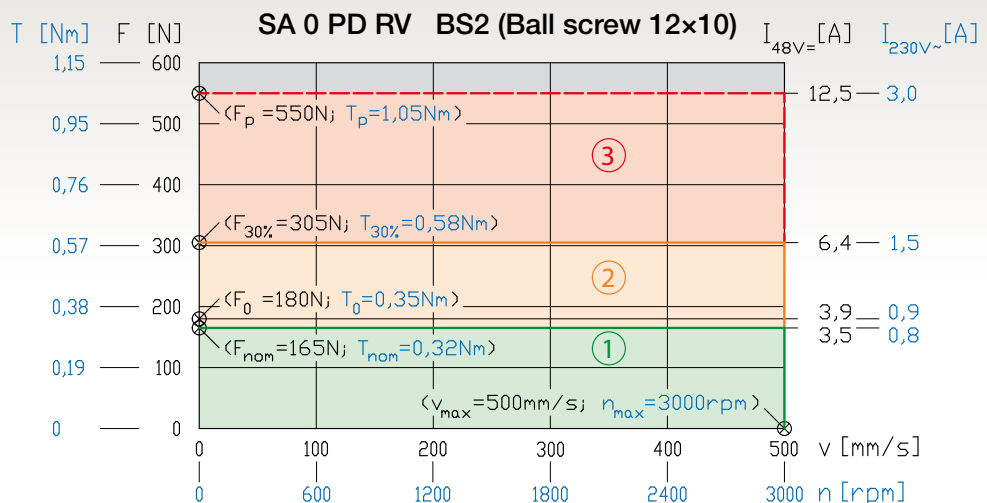

5.4 Performances

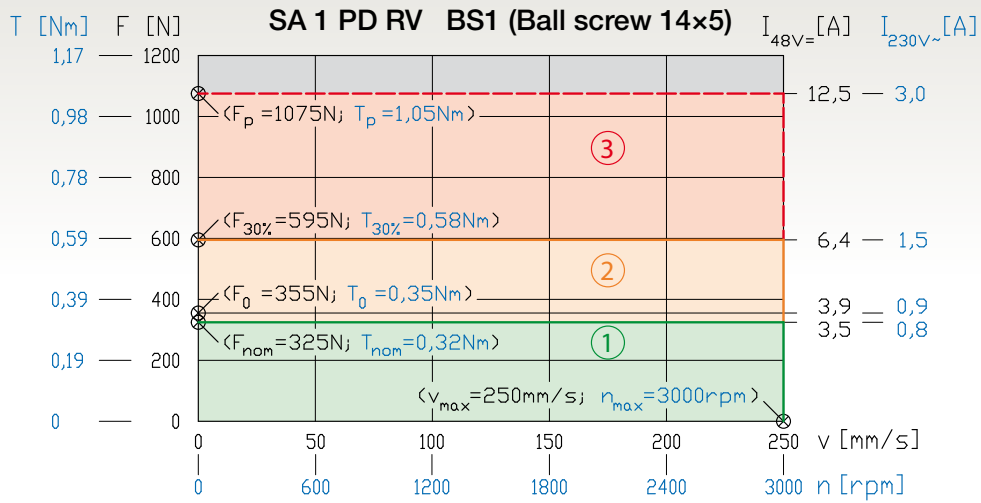

5.4.2 SA 1 PD

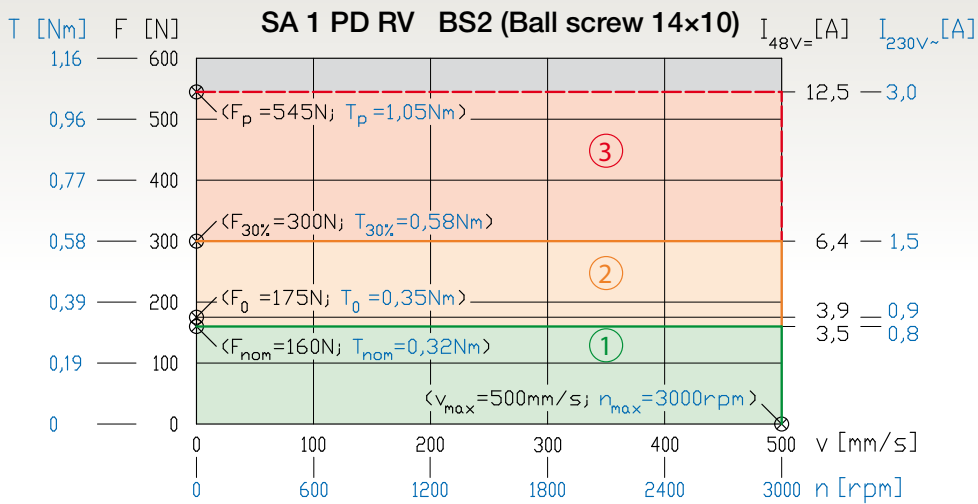

5.4.2 SA 1 PD

5.4 Performances

5.4.3 SA 2 PD

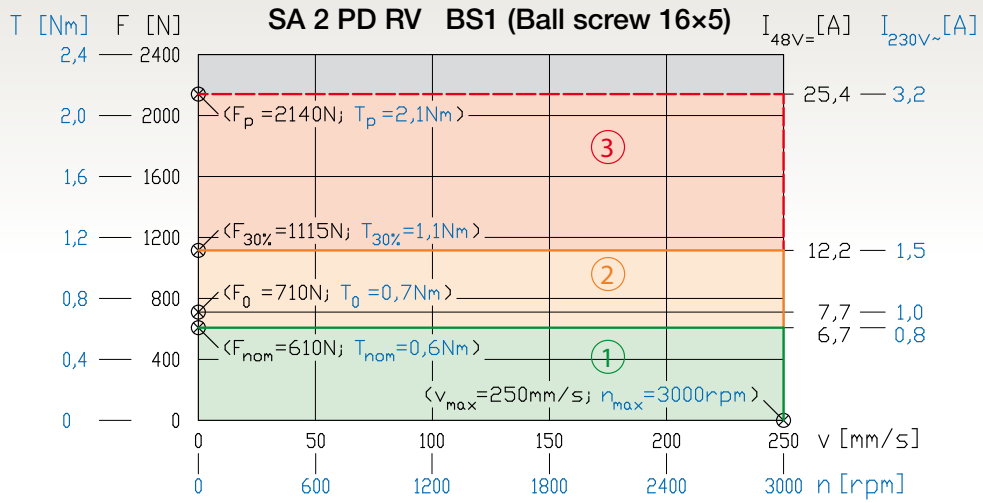

5.4.3 SA 2 PD

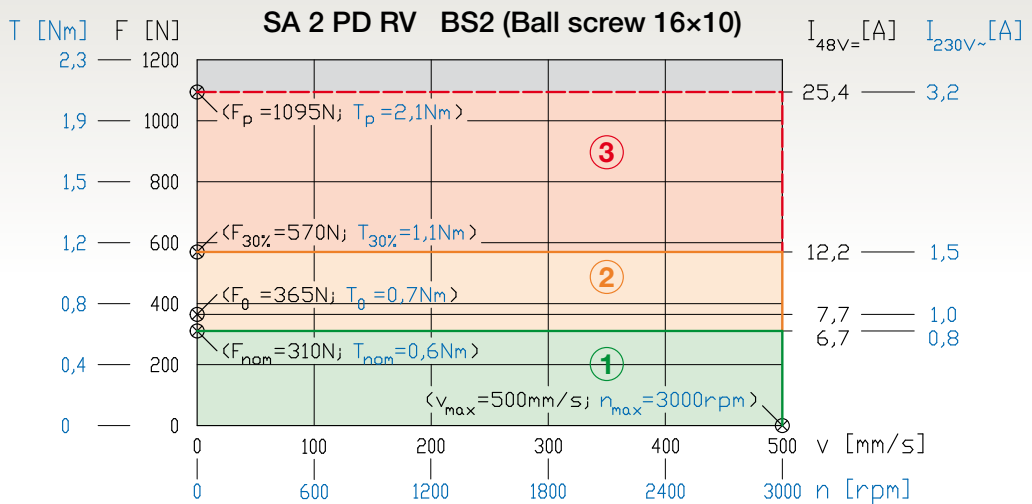

5.4.3 SA 2 PD

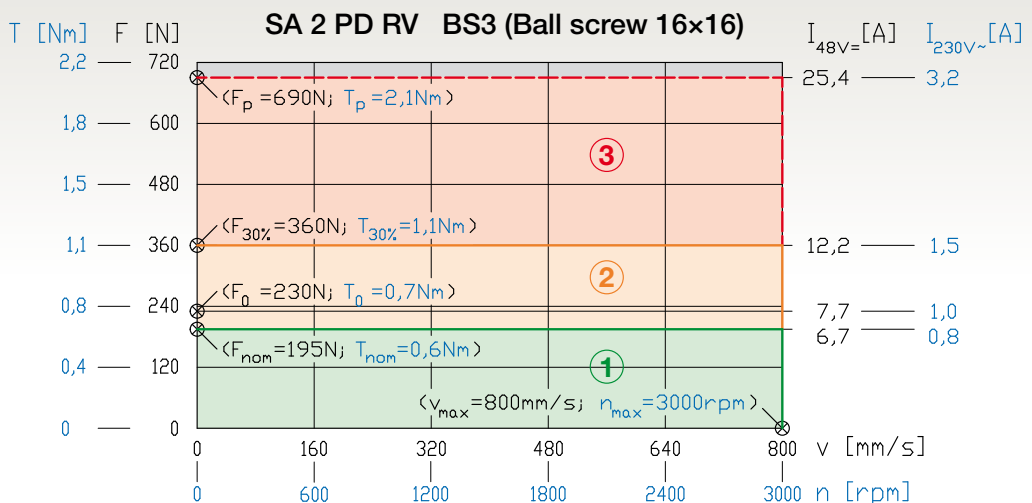

5. SAPD Series Servoactuators



WARNING: the following performance diagrams refer to the motor maximum torque. A possible performance degrading shall occur depending on drive model type, as specified in Chapter 12.8 on pages 102-103.

5.4.4 SA 3 PD

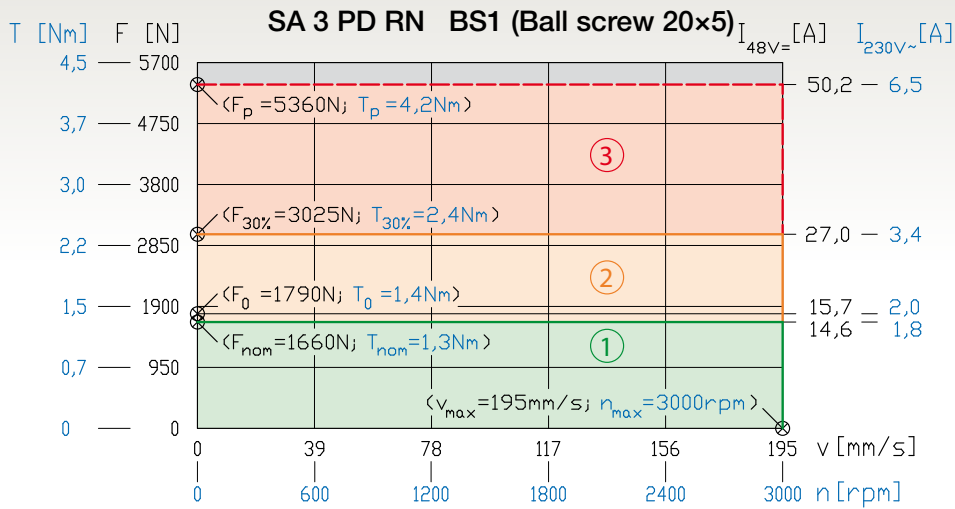

5.4.4 SA 3 PD

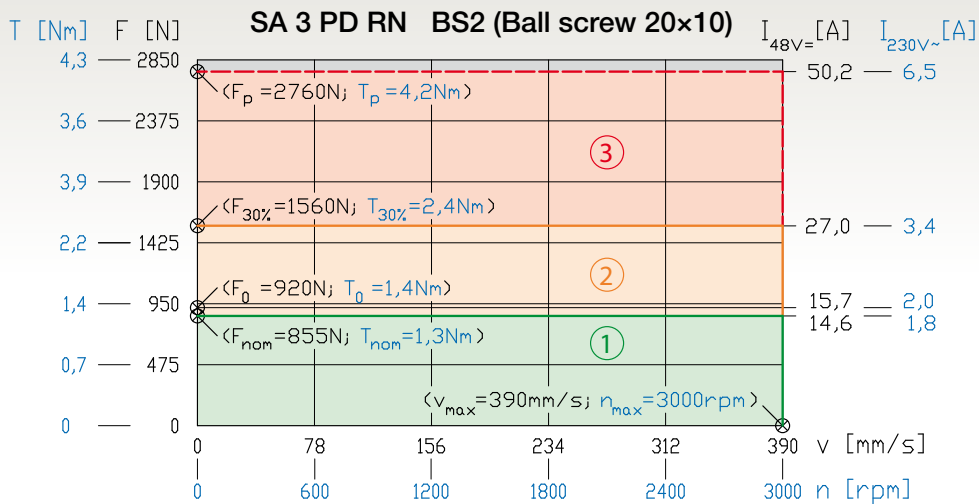

5.4.4 SA 3 PD

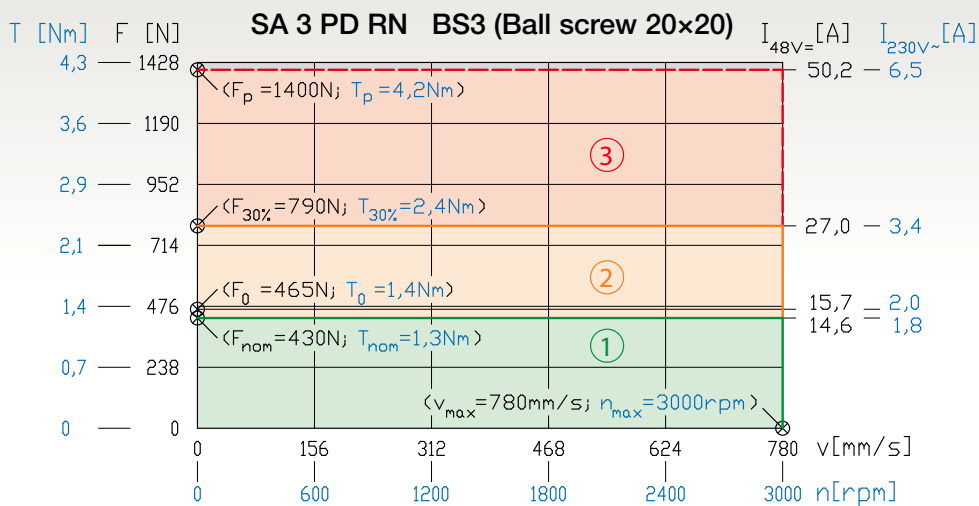

5.4 Performances

5.4.4 SA 3 PD

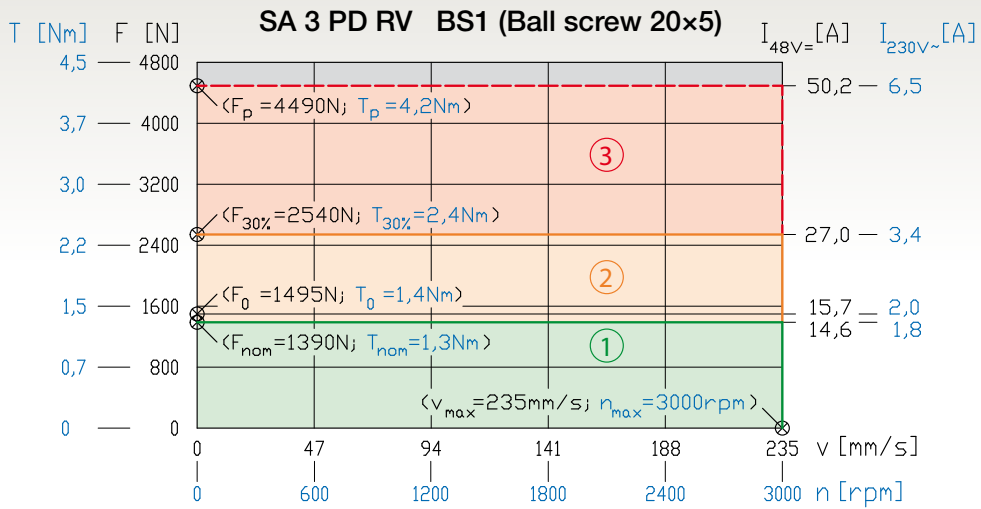

5.4.4 SA 3 PD

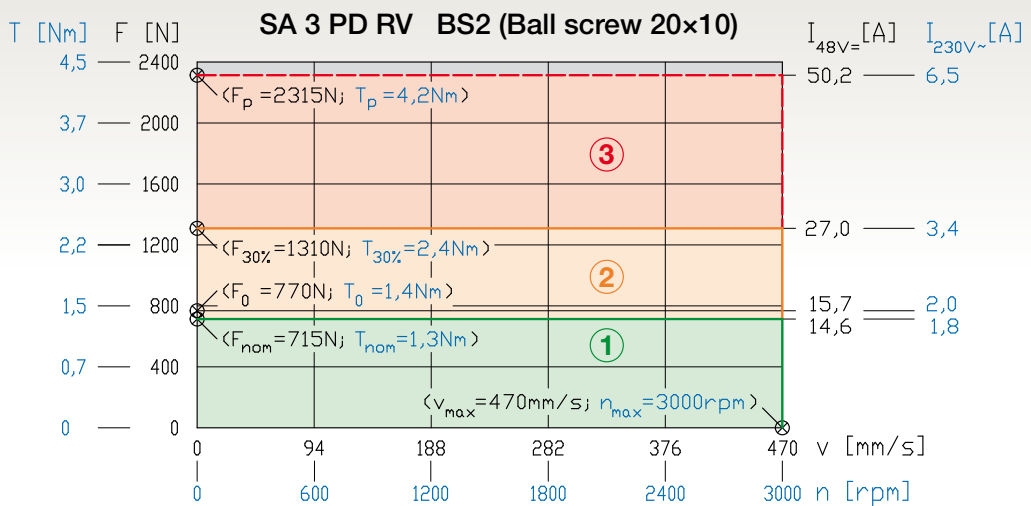

5.4.4 SA 3 PD

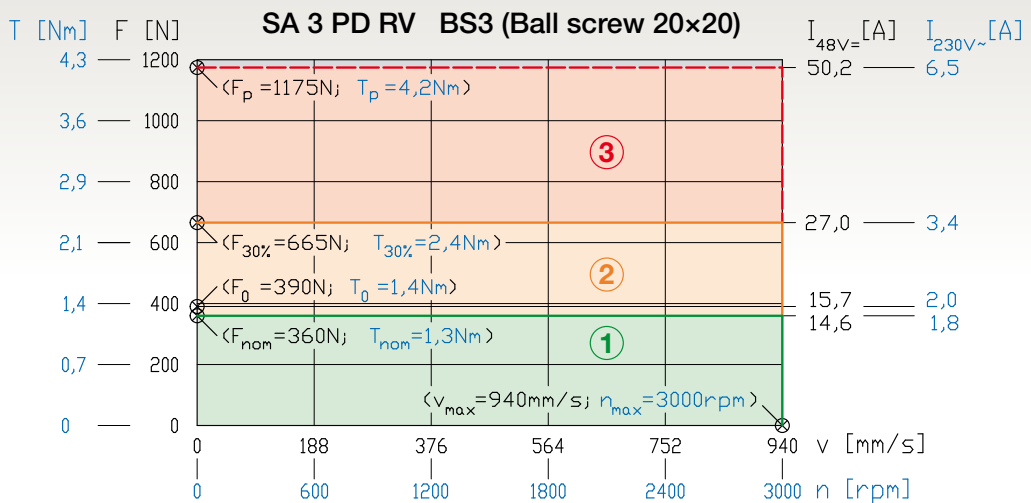

5. SAPD Series Servoactuators



WARNING: the following performance diagrams refer to the motor maximum torque. A possible performance degrading shall occur depending on drive model type, as specified in Chapter 12.8 on pages 102-103.

5.4.5 SA 4 PD

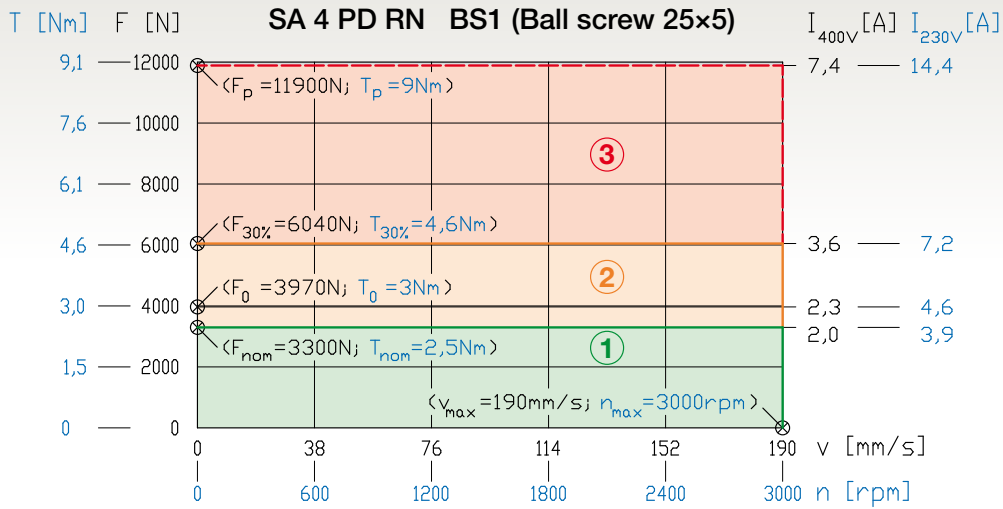

5.4.5 SA 4 PD

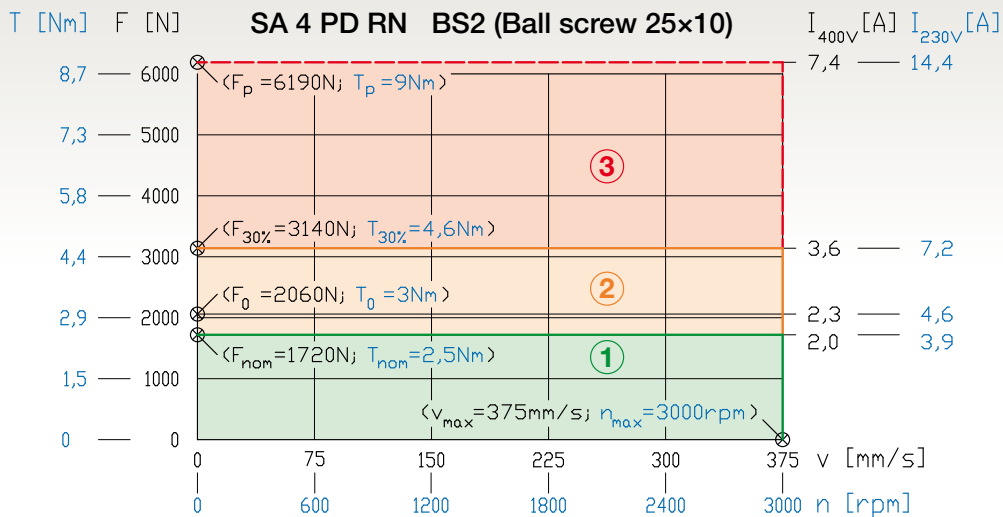

5.4.5 SA 4 PD

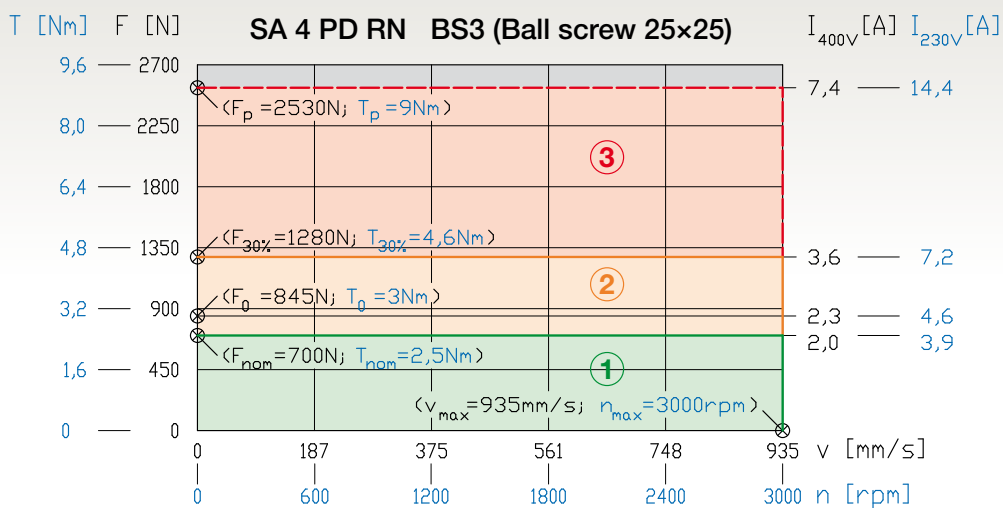

5.4 Performances

5.4.5 SA 4 PD

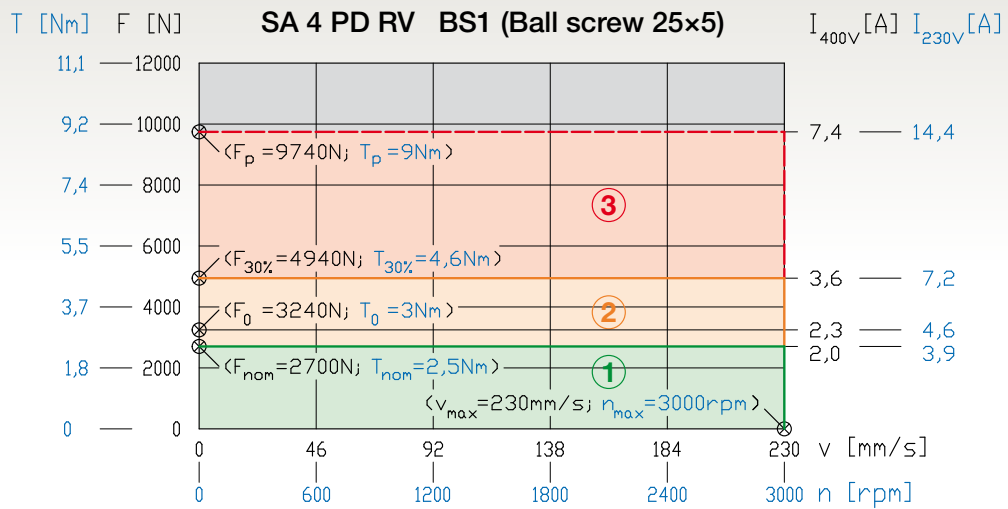

5.4.5 SA 4 PD

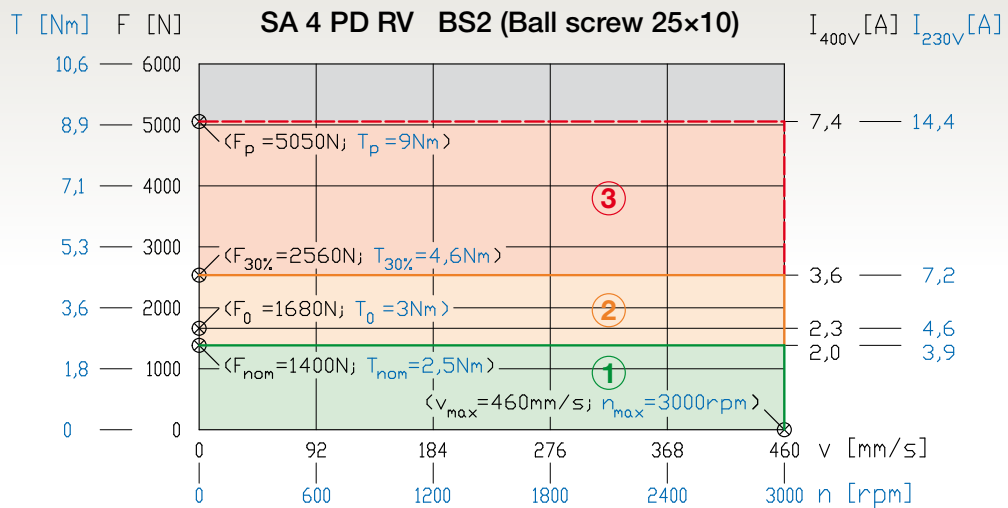

5.4.5 SA 4 PD

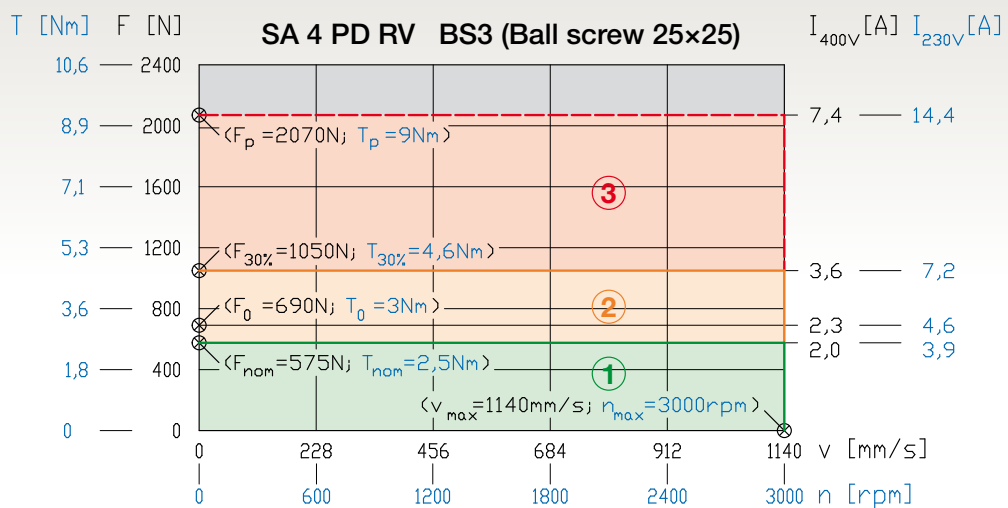

5. SAPD Series Servoactuators



WARNING: the following performance diagrams refer to the motor maximum torque. A possible performance degrading shall occur depending on drive model type, as specified in Chapter 12.8 on pages 102-103.

5.4.6 SA 5 PD

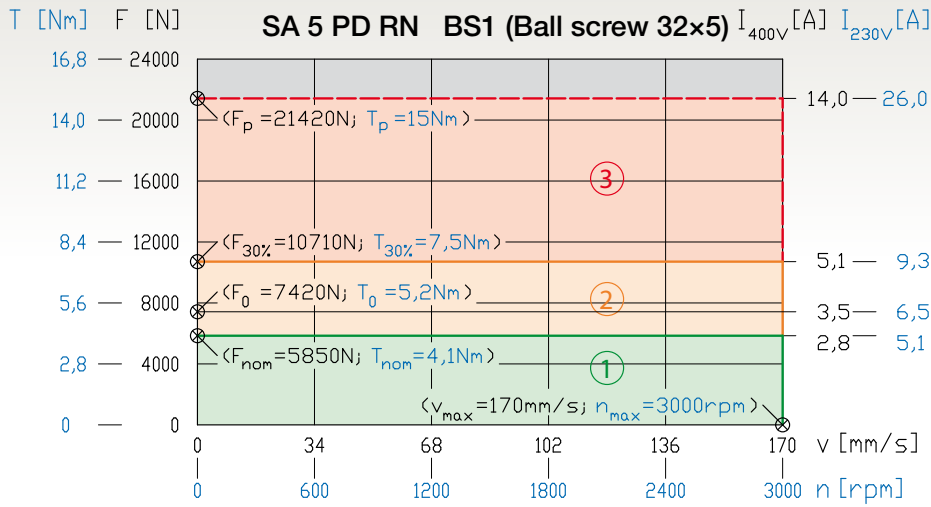

5.4.6 SA 5 PD

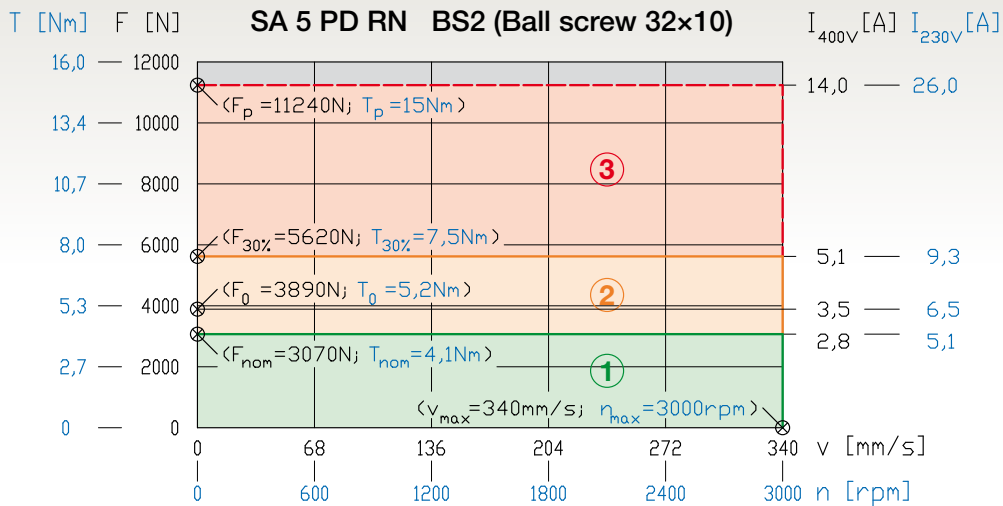

5.4.6 SA 5 PD

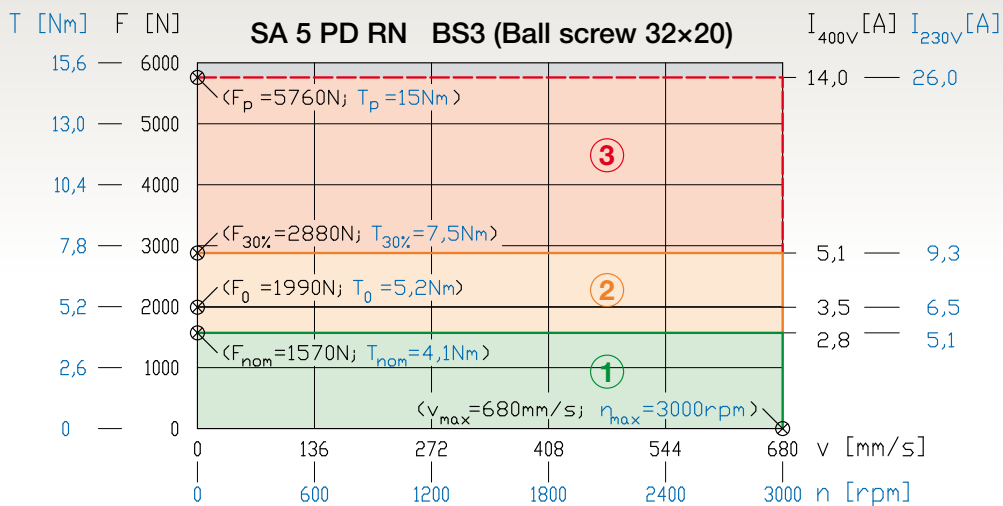

5.4 Performances

5.4.6 SA 5 PD

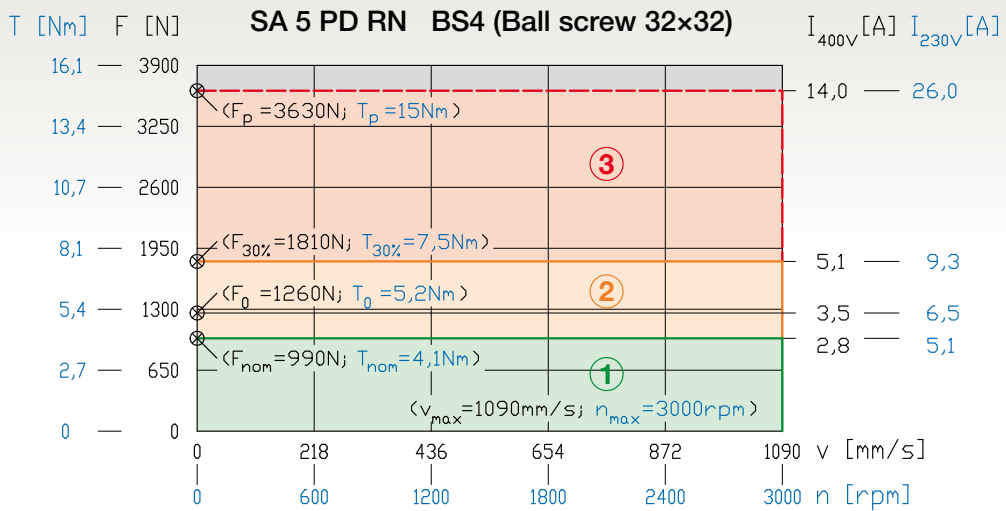

5.4.6 SA 5 PD

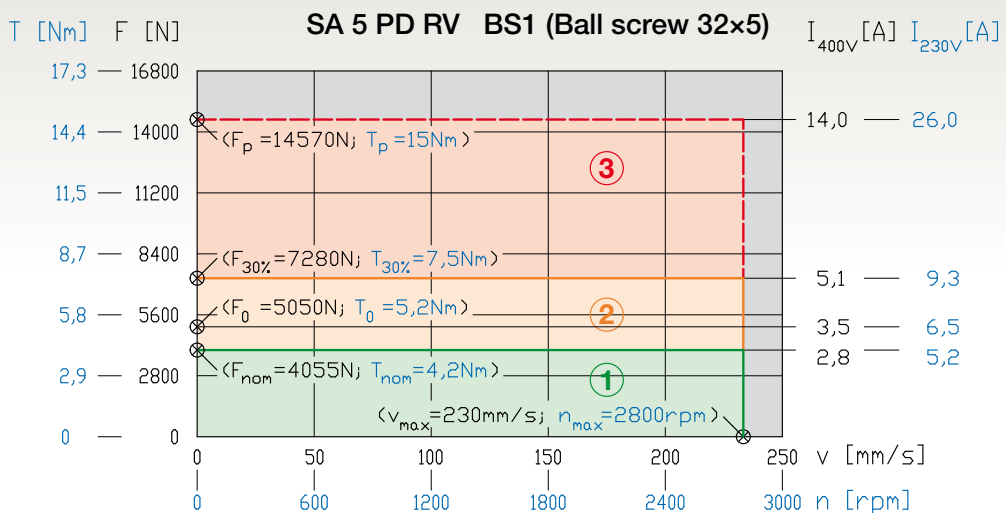

5.4.6 SA 5 PD

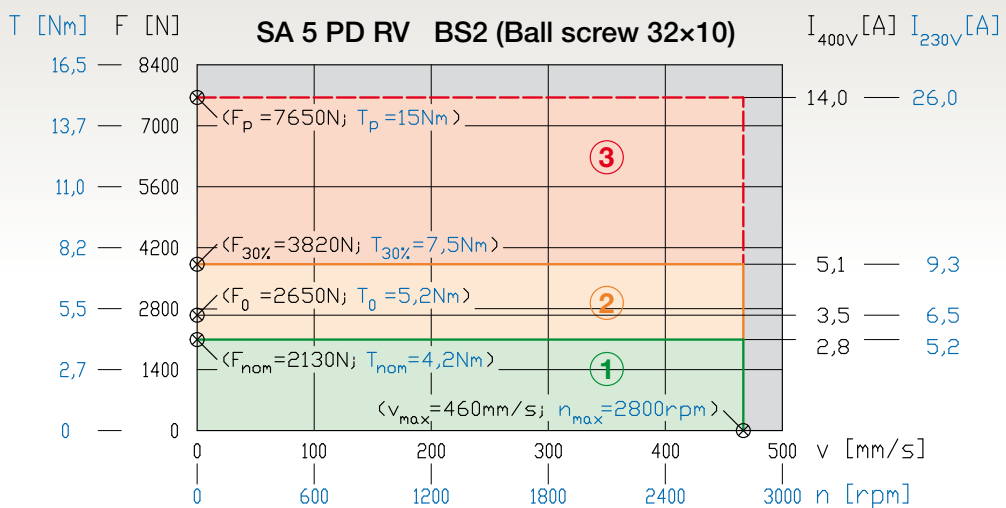

5. SAPD Series Servoactuators



WARNING: the following performance diagrams refer to the motor maximum torque. A possible performance degrading shall occur depending on drive model type, as specified in Chapter 12.8 on pages 102-103.

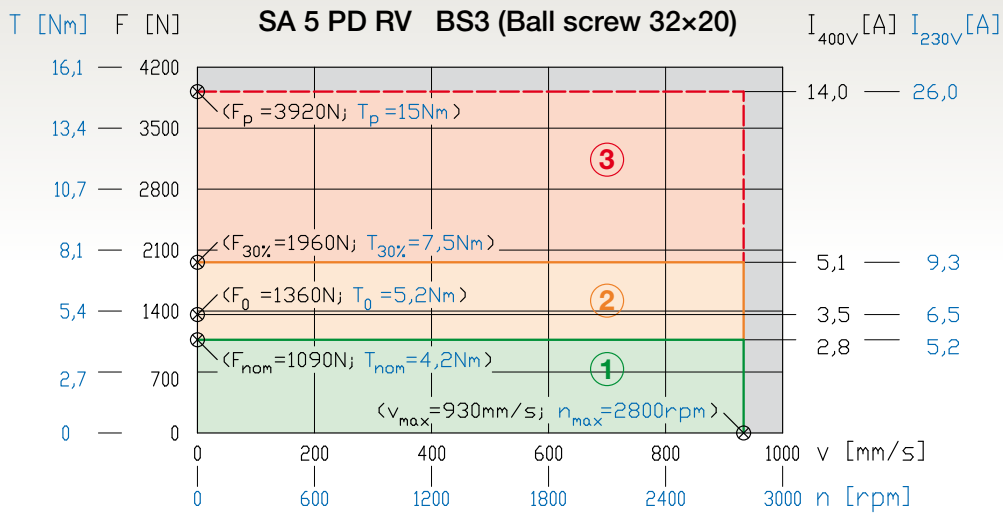

5.4.6 SA 5 PD

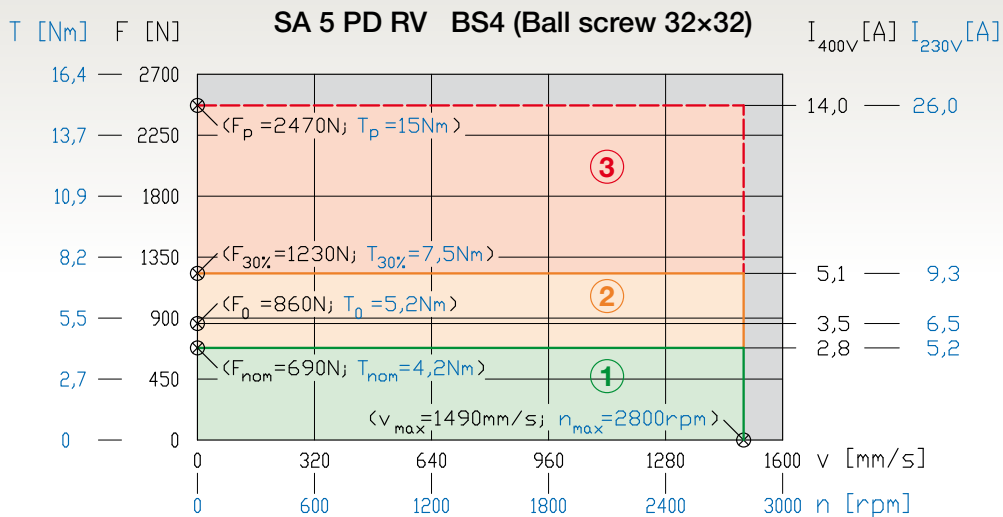

5.4.6 SA 5 PD

5.4 Performances

5.4.7 SA 6 PD

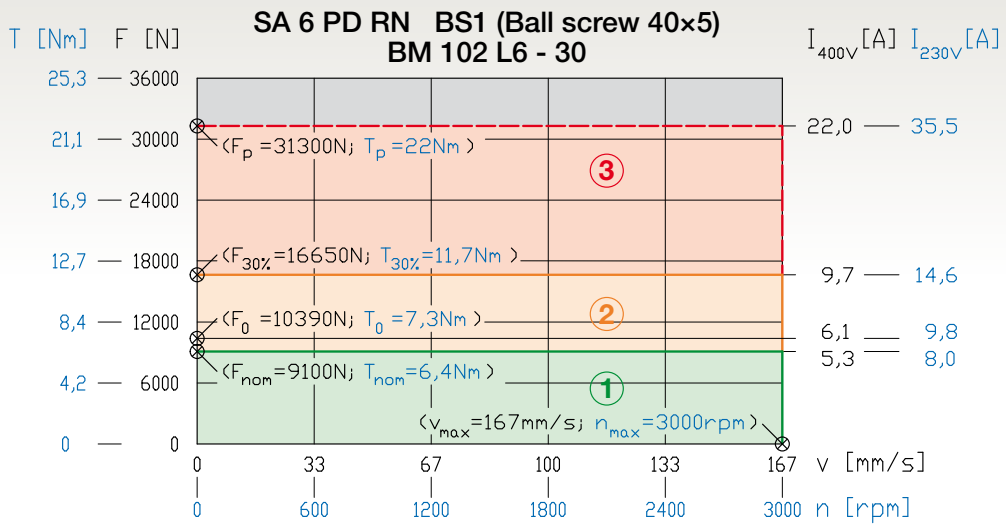

5.4.7 SA 6 PD

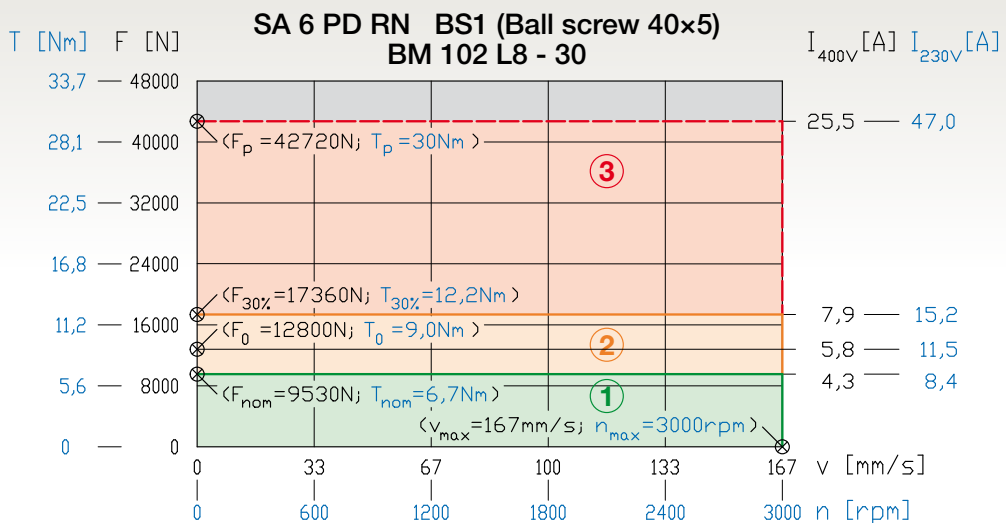

5.4.7 SA 6 PD

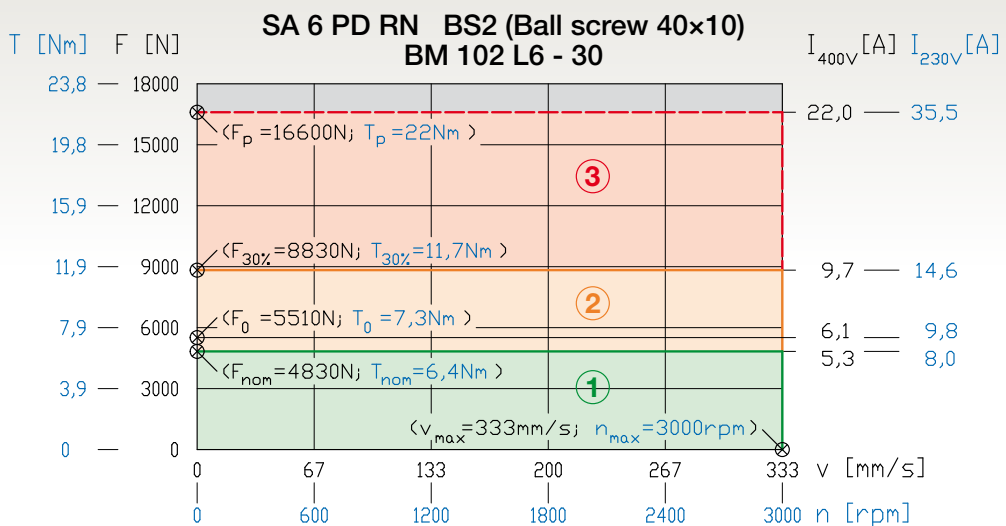

5. SAPD Series Servoactuators



WARNING: the following performance diagrams refer to the motor maximum torque. A possible performance degrading shall occur depending on drive model type, as specified in Chapter 12.8 on pages 102-103.

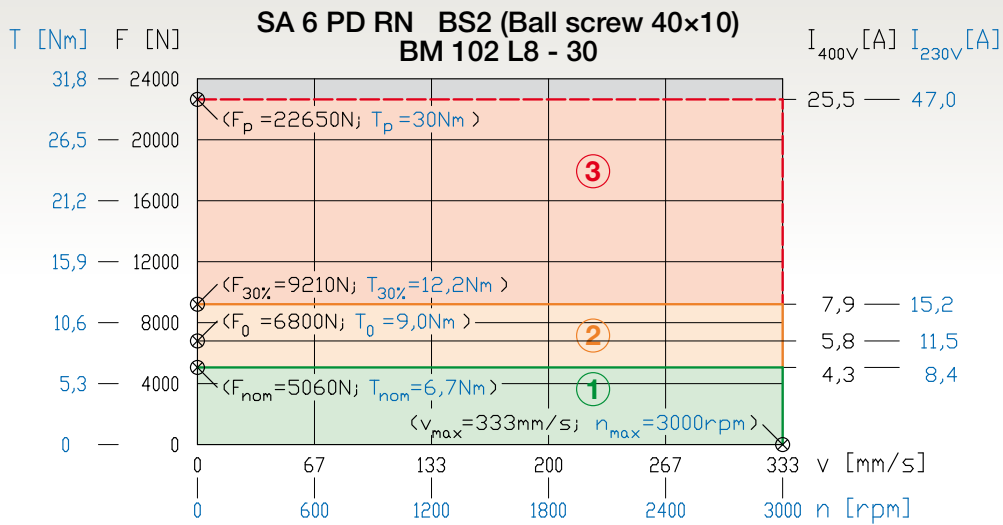

5.4.7 SA 6 PD

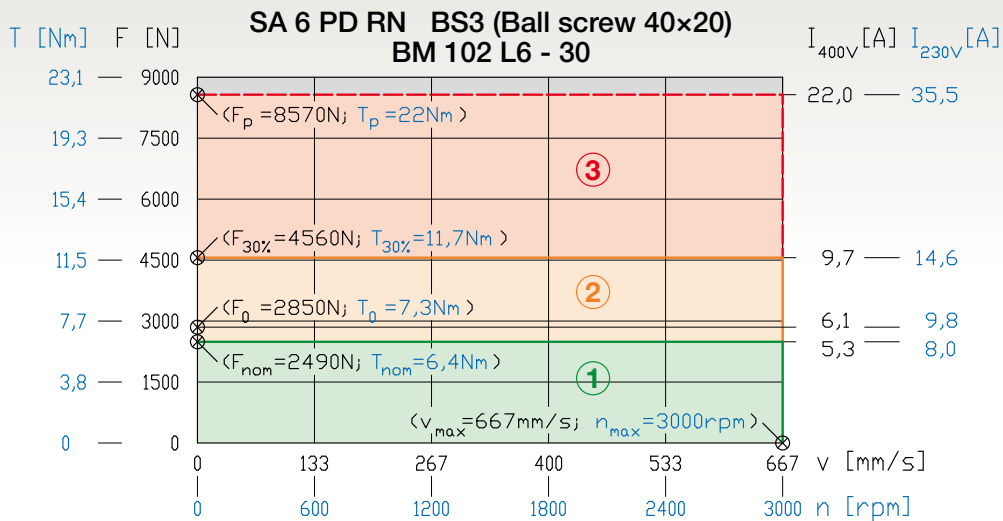

5.4.7 SA 6 PD

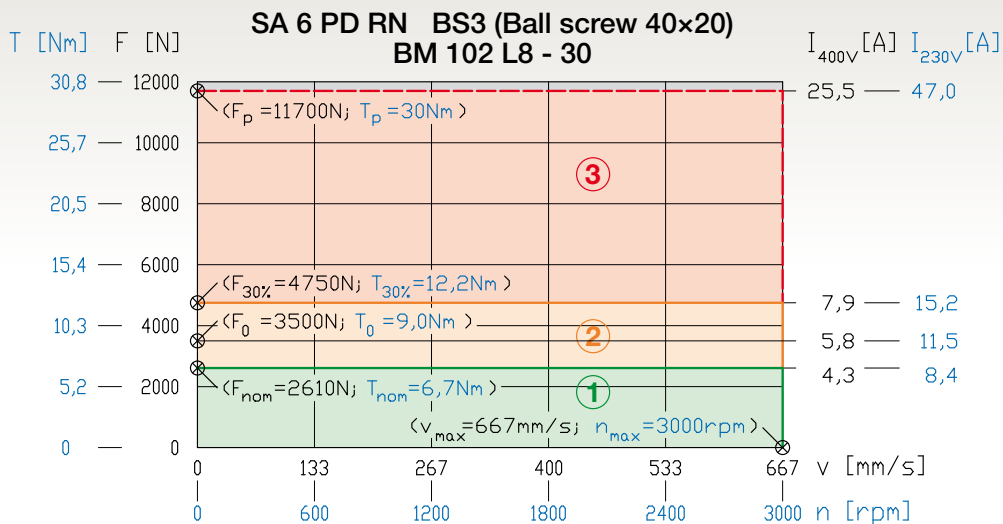

5.4.7 SA 6 PD

5.4 Performances

5.4.7 SA 6 PD

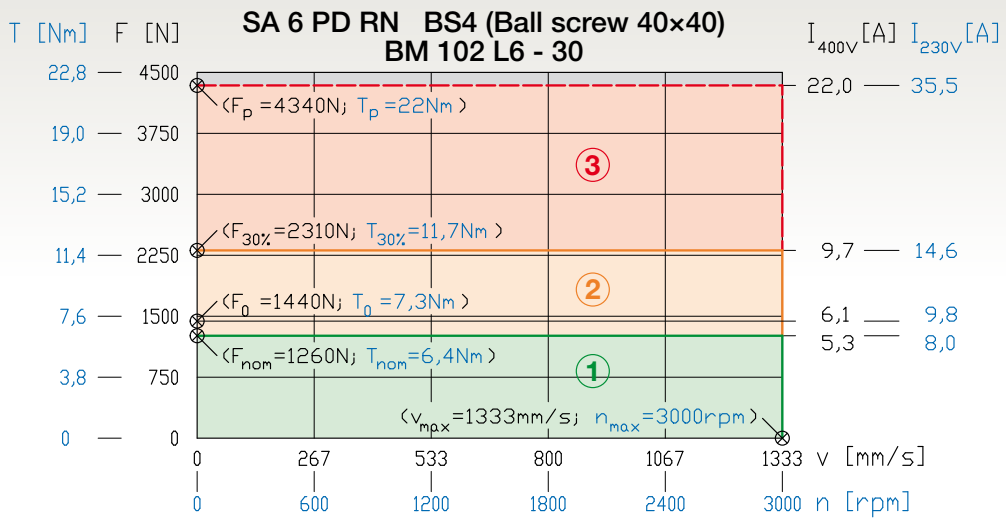

5.4.7 SA 6 PD

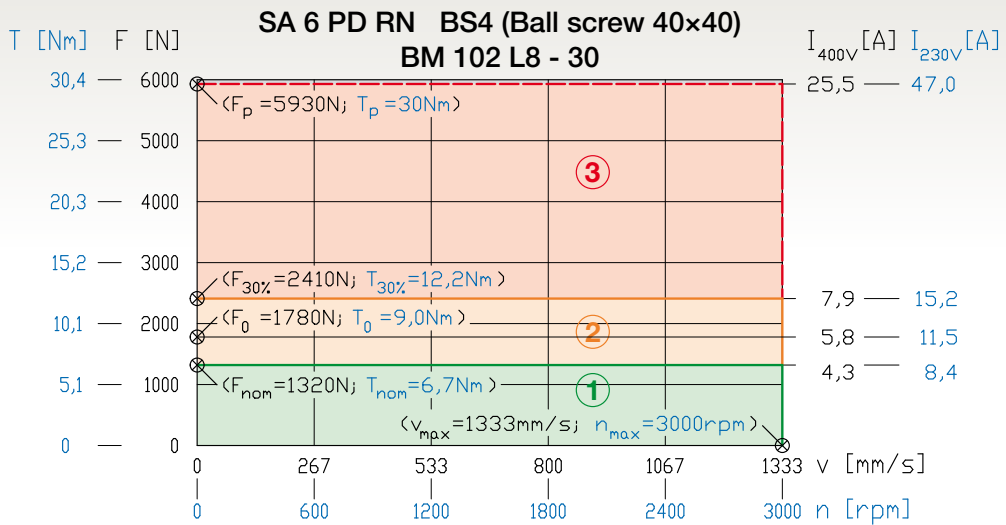

5.4.7 SA 6 PD

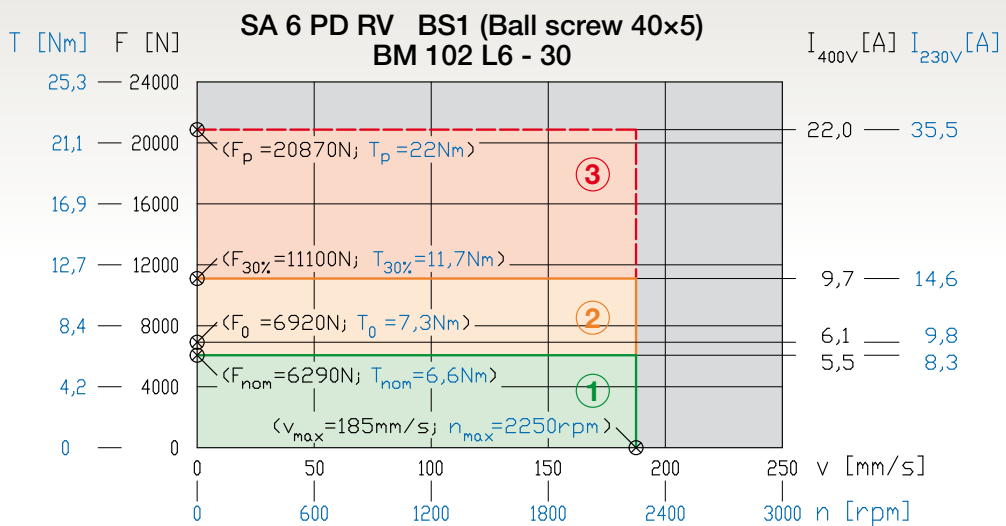

5. SAPD Series Servoactuators



WARNING: the following performance diagrams refer to the motor maximum torque. A possible performance degrading shall occur depending on drive model type, as specified in Chapter 12.8 on pages 102-103.

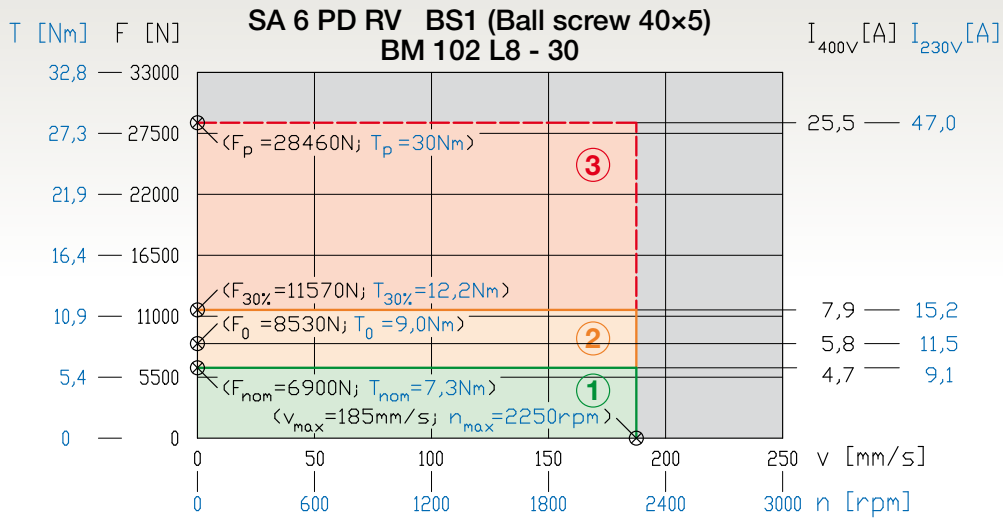

5.4.7 SA 6 PD

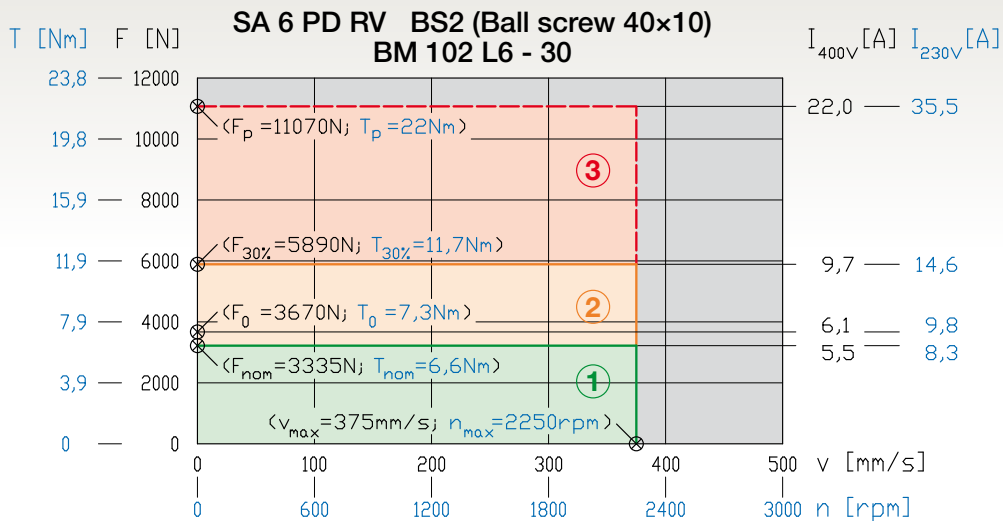

5.4.7 SA 6 PD

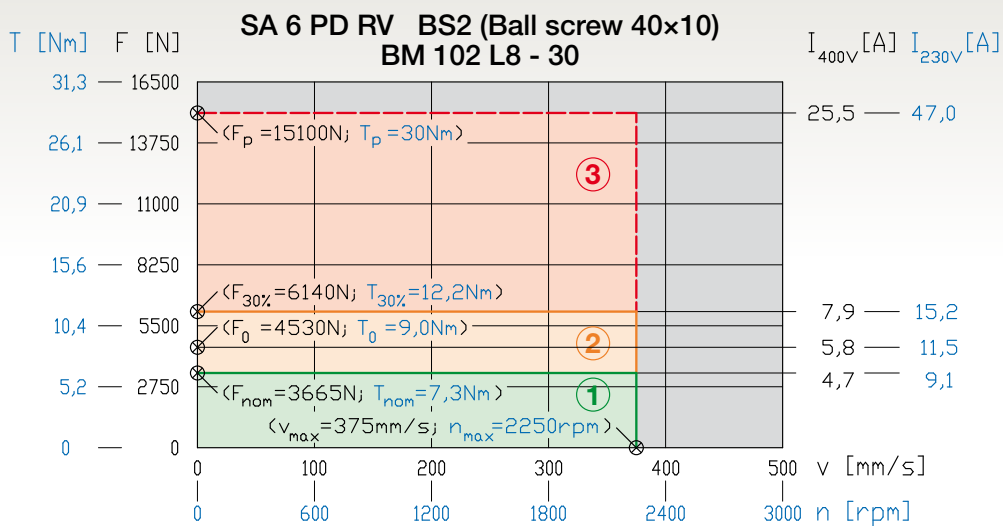

5.4.7 SA 6 PD

5.4 Performances

5.4.7 SA 6 PD

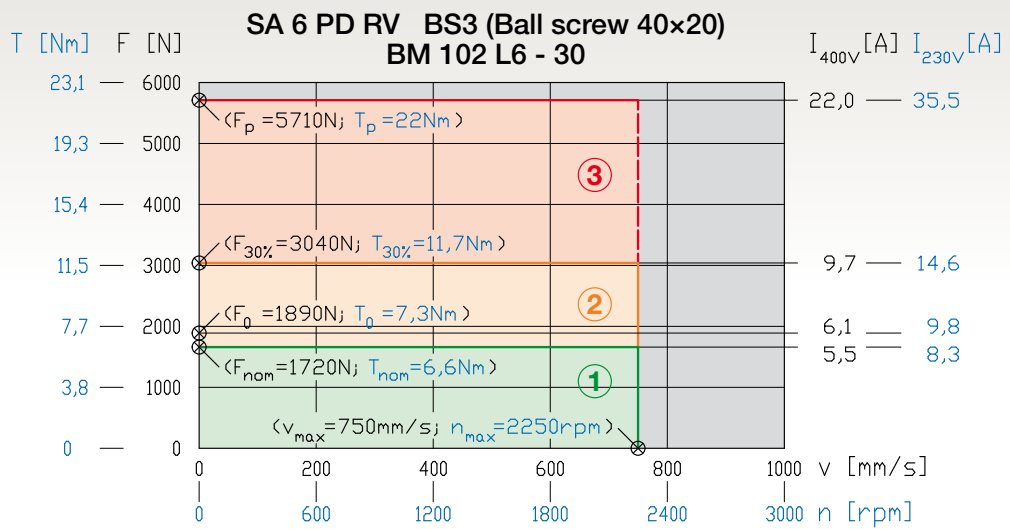

5.4.7 SA 6 PD

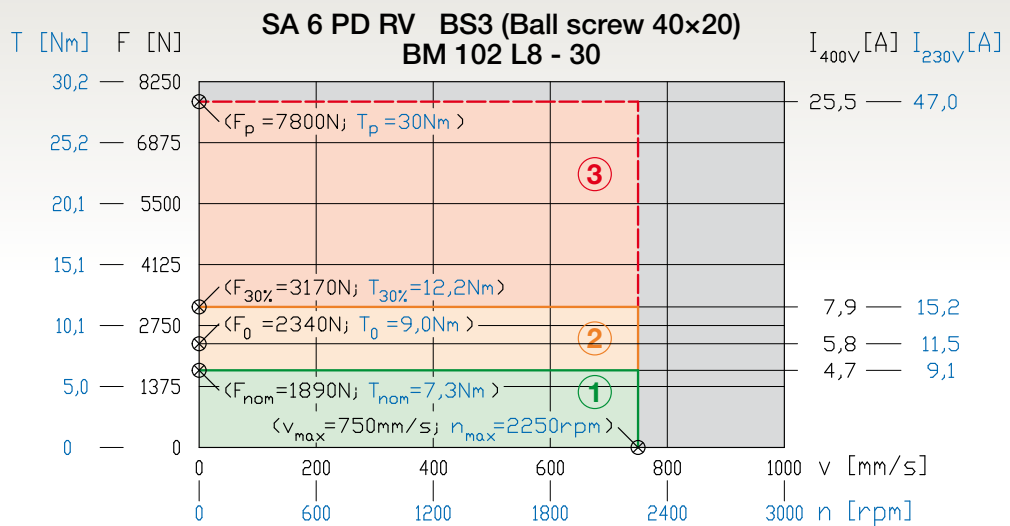

5. SAPD Series Servoactuators



WARNING: the following performance diagrams refer to the motor maximum torque. A possible performance degrading shall occur depending on drive model type, as specified in Chapter 12.8 on pages 102-103.

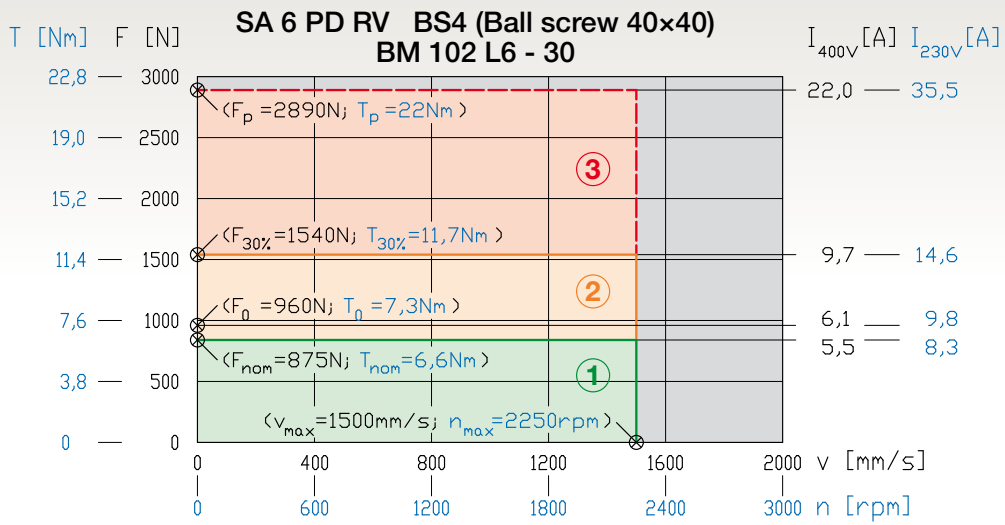

5.4.7 SA 6 PD

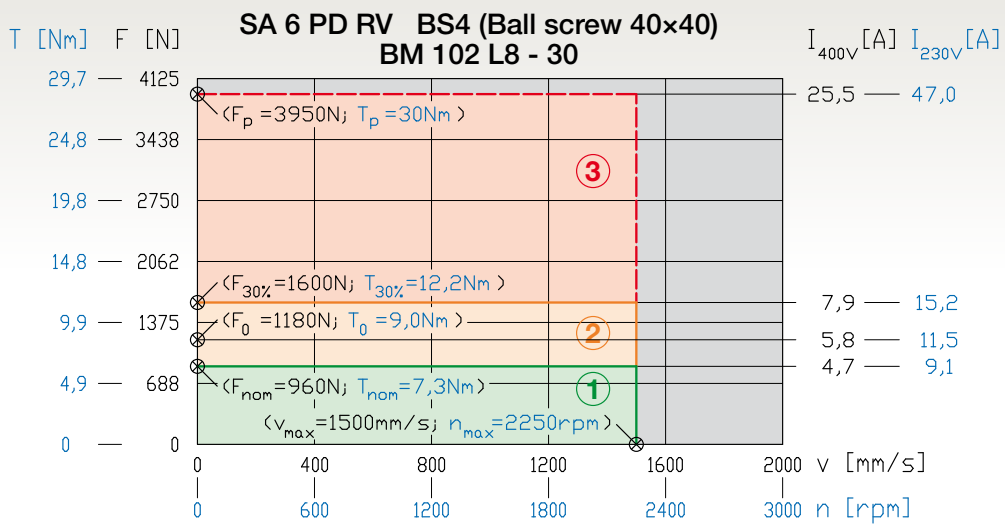

5.4.7 SA 6 PD

This chapter is about how to properly define the required motor torque, thermal testing of the servomotor and finally the selection of the drive.

LINEARMECH can support you also providing a **full package solution** with the advantage of having a sole responsible partner from the initial phase of product selection up to the start-up operations of your applications.

LINEARMECH product range also includes **Brushless Servomotors BM Series**, produced according to the latest state-of-the-art technology to improve the specific torque and its linear erogation, and **Drives ECO Series**, specifically engineered and developed for linear motion needs in Automation Industry.

Learn more on Chapter 11 Brushless Servomotors BM Series and Chapter 12 Drives ECO Series.

Brushless Servomotors and Drives



6.1 Required motor torque

Servomotor has to supply the necessary torque which allows the actuator to work properly in the effective working conditions, in terms of load (actual load to which is subjected) and linear speed (referring to the linear speed profile in the requested time).

The load on the actuator axis is the result of load due to inertial effects (F_{in}) during acceleration or braking phases, and external loads (not due to inertial effects) as:

- the component of weight of the mass to be moved F_p (weight of moving parts of the actuator are included; see the m value reported on the relative table of performances) acting in the direction of the actuator axis; in case of horizontal axis, this component is zero
- force due to the friction of external guides F_a , if present
- other forces, if present.

The component of **motor torque due to inertial effects** T_J can be calculated as follows:

$$T_J = \left[J_0 + J_{100} \cdot \frac{C}{100} + \frac{M}{\eta} \cdot \left(\frac{P_h}{2000\pi \cdot u} \right)^2 \right] \frac{a \cdot 2000\pi \cdot u}{P_h}$$

where:

J_0 [kg×m²] = moment of inertia of the actuator referred to the motor shaft for stroke = 0 mm

J_{100} [kg×m²] = moment of inertia of the actuator referred to the motor shaft for each 100 mm stroke

C [mm] = linear travel (stroke) of the actuator

M [kg] = external mass to be moved

P_h [mm] = thread helix lead of the ball screw

u = ratio ($u \geq 1$; for servoactuators SA or SA IL Series: $u = 1$)

a [m/s²] = acceleration sustained by the load

η = total efficiency of the actuator

The component of **motor torque due to external forces** T_e can be calculated as follows:

$$T_e = \frac{(F_p + F_a + \dots)P_h}{2000\pi \cdot u \cdot \eta}$$

where:

P_h [mm] = thread helix lead of the ball screw

u = ratio ($u \geq 1$; for servoactuators SA or SA IL Series: $u = 1$)

η = total efficiency of the actuator

Then, the **total torque** T_M which the servomotor has to supply to the actuator is:

$$T_M = T_J + T_e$$

6.2 Thermal verification of the servomotor

6.2.1 RMS torque

When the drive working cycle is defined, i.e. the motor torque trend in a variable period, you can calculate the **RMS value of the motor torque** T_{RMS} : it is the torque which generates inside the servomotor so much heat as during the effective working cycle. The simplest conditions, when the working cycle has constant acceleration or zero acceleration phases, provide a torque with constant intervals trend, as shown below.

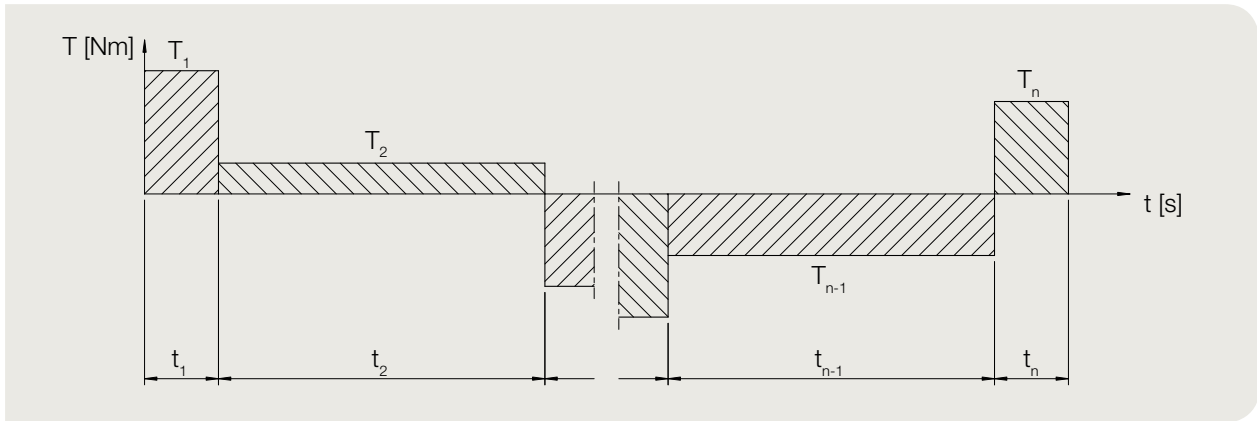

In this case, the RMS value of the motor torque can be calculated as follows:

$$T_{RMS} = \sqrt{\frac{\sum_i T_{Mi}^2 \cdot t_i}{t_{tot}}}$$

where:

T_{RMS} [Nm] = RMS value of the motor torque

T_{Mi} [Nm] = motor torque of the i-th cycle phase

t_i [s] = time of the i-th cycle phase

$t_{tot} = \sum_i t_i$ [s] = total cycle time

For the thermal verification of the servomotor it must be:

$$T_{RMS} \leq T_{nom,100K}$$

where:

T_{RMS} [Nm] = RMS value of the motor torque

$T_{nom,100K}$ [Nm] = constant rated torque of the servomotor (see Chapter 11.3 on pages 88-91)

6.2.2 Peak torque

For a correct selection of the servomotor, it should be able to supply the maximum requested torque during the working cycle. It occurs when this relation is satisfied:

$$(T_M)_{max} \leq T_p$$

where:

$(T_M)_{max}$ [Nm] = max torque of the actuator working cycle

T_p [Nm] = peak torque that the servomotor can supply (see Chapter 11.3 on pages 88-91)

6.3 Drive selection

The servomotor drive shall be able to supply the power required by the servomotor to give the necessary torque at any time. As for the servomotor, the verification of the drive must be done both for RMS torque and maximum torque. This verification is necessary because the servomotor performances could change in function of the specific drive coupling.

6.3.1 RMS torque

After calculating the RMS value of the motor torque T_{RMS} as shown in Chapter 6.2.1 on page 59, you must obtain:

$$T_{RMS} \leq T_{nom,100K}$$

where:

T_{RMS} [Nm] = RMS value of the motor torque

$T_{nom,100K}$ [Nm] = constant rated torque of the servomotor with the selected drive

(see Chapter 12.8, pages 102-103)

In case you choose a drive that is NOT supplied by Linearmech, an appropriate drive selection must be done to supply a nominal current higher than the servomotor stall current ($I_{0,100K}$), i.e:

$$(I_{nom})_{drive} > (I_{0,100K})_{motor}$$

6.3.2 Peak torque

This condition must be satisfied:

$$(T_M)_{max} \leq T_p$$

where

$(T_M)_{max}$ [Nm] = max torque of the actuator working cycle

T_p [Nm] = peak torque that the servomotor can supply with the selected drive

(see Chapter 12.8, pages 102-103)

In case you choose a drive that is NOT supplied by Linearmech, an appropriate drive selection must be done to supply a peak current greater or equal than the servomotor peak current (I_p), i.e:

$$(I_p)_{drive} \geq (I_p)_{motor}$$

7.1 Lifetime calculation

Ball screws life corresponds to the number of revolutions that the screw can perform with regard to its nut before any sign of fatigue appears on the material of screw, nut and rolling elements.

The **nominal ball screw life** (L_{10}) is calculated with the following formula:

$$L_{10} = \left(\frac{C_a}{F_m \cdot f_{sh}} \right)^3 \cdot 10^6$$

where:

L_{10} [giri] = nominal ball screw life

C_a [N] = ball screw dynamic load

F_m [N] = equivalent dynamic load

f_{sh} = shock factor

$f_{sh} = 1$:	load without shocks
$1 < f_{sh} \leq 1.3$:	load with light shocks
$1.3 < f_{sh} \leq 1.8$:	load with medium shocks
$1.8 < f_{sh} \leq 3$:	load with heavy shocks

The result of the calculation corresponds to the number of revolutions of the screw with regard to the nut, reached by the 90 % of the ball screw, apparently identical, subject to the same load conditions, motion laws and environment conditions.

The **equivalent dynamic load** (F_m) is defined as a hypothetical load concentric to the screw, axial only, with constant width and direction that, if applied, would have the same effects on the ball screw life as the real applied load. To determine it, the working cycle is divided in distinct and separate phases, each of them characterized by its load level, the specific rotating speed and the relevant time of load application.

$$F_m = \sqrt[3]{\sum_i F_i^3 \cdot \frac{n_i}{n_m} \cdot \frac{t_i}{t_{tot}}}$$

where:

t_i = duration of each single phase

F_i = load level for each single phase

n_i = rotating speed for each single phase

$$n_m = \sum_i n_i \cdot \frac{t_i}{t_{tot}}$$

$$t_{tot} = \sum_i t_i$$

If a preloaded nut is used, the equivalent dynamic load is determined taking into consideration also the preload force, adding it to the load level of each single phase of the working cycle.

Example:

i	t_i [s]	n_i [rpm]	F_i [N]	n_m [rpm]	F_m [N]
1	25	200	10 000	585	5 508
2	40	900	5 000		
3	35	500	2 500		

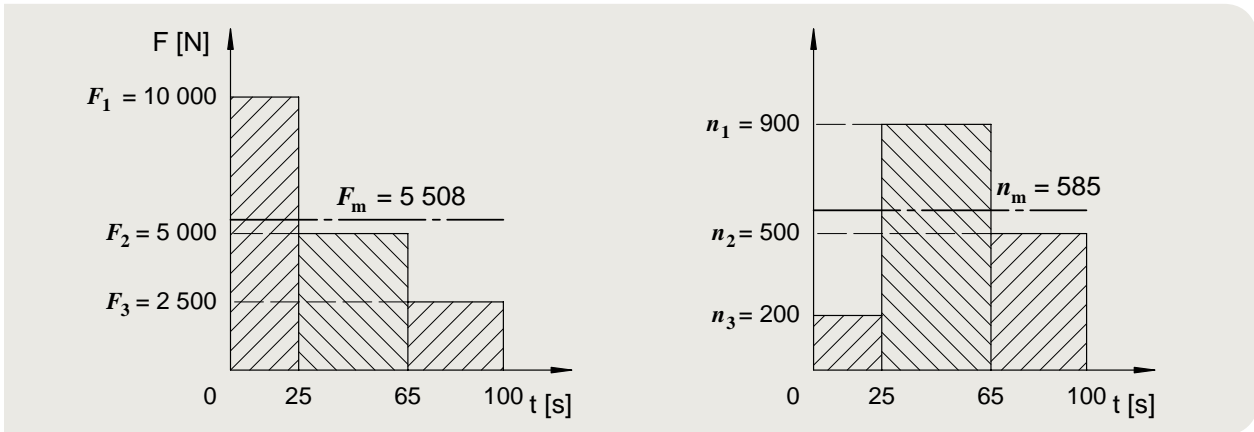

The **ball screw life expressed in hours** (L_{10h}) is calculated as follows:

$$L_{10h} = \frac{L_{10}}{60 \cdot n_m}$$

where:

n_m [rpm] = equivalent rotating speed

The previous formulas regarding the life refer to a ball screw reliability of 90%. If a higher life reliability is required (**modified ball screw life**, L_{10m}), the correction factor f_a must be applied:

$$L_{10m} = L_{10} \cdot f_a$$

Reliability [%]	90	95	96	97	98	99
Factor f_a	1	0.62	0.53	0.44	0.33	0.21

For servoactuators, the **ball screw life expressed in kilometres of travel** (L_{10km}) is calculated as follows:

$$L_{10km} = \left(\frac{C_a}{F_m \cdot f_{sh}} \right)^3 \cdot P_h$$

where:

P_h [mm] = thread helix lead

The equivalent dynamic load F_m shall be calculated as shown previously, where for each phase external, mass (weight and inertial) and friction loads must be considered.

7.2 Ball screw lifetime

For a easier and faster consultation, following diagrams show the limit conditions for each servoactuator size and for each screw type. The used symbols have following meanings:

- F_m [N] = equivalent dynamic load
- L_{10km} [km] = ball screw life expressed in kilometres of travel
- v [mm/s] = linear speed

The application speed limits stated in the diagrams are due to the max. linear translation speed for internal factors (see Chapter 7.4.b on page 77).

7.2.1 Size 0 Servoactuator

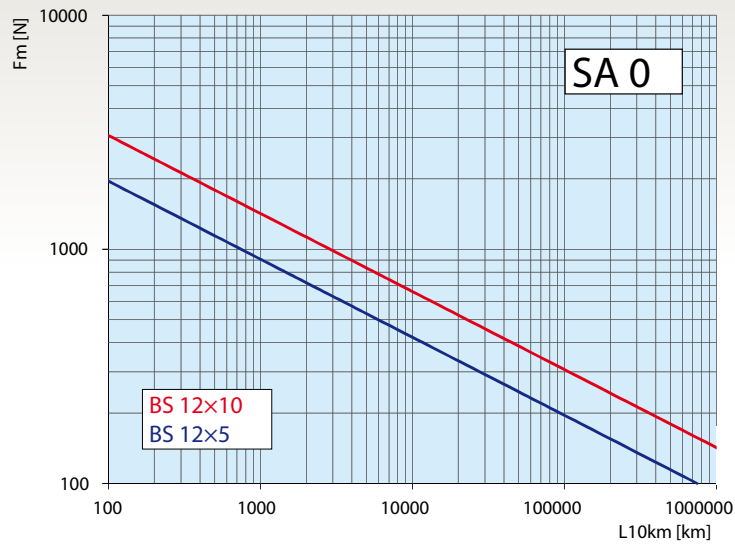

7.2.1 Size 0 Servoactuator

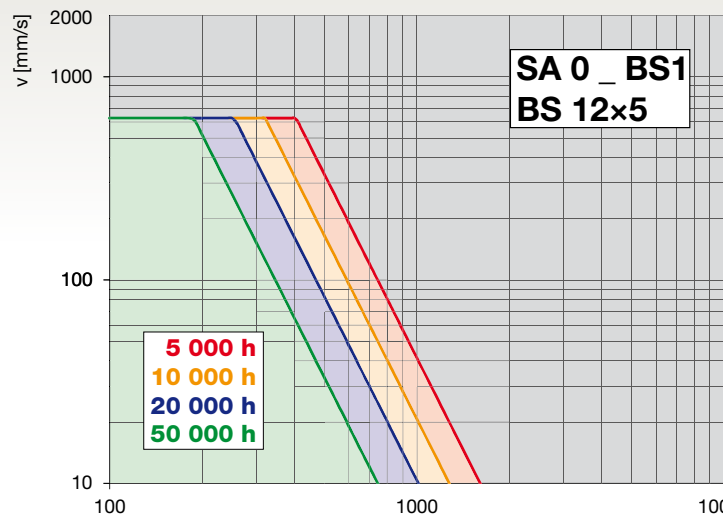

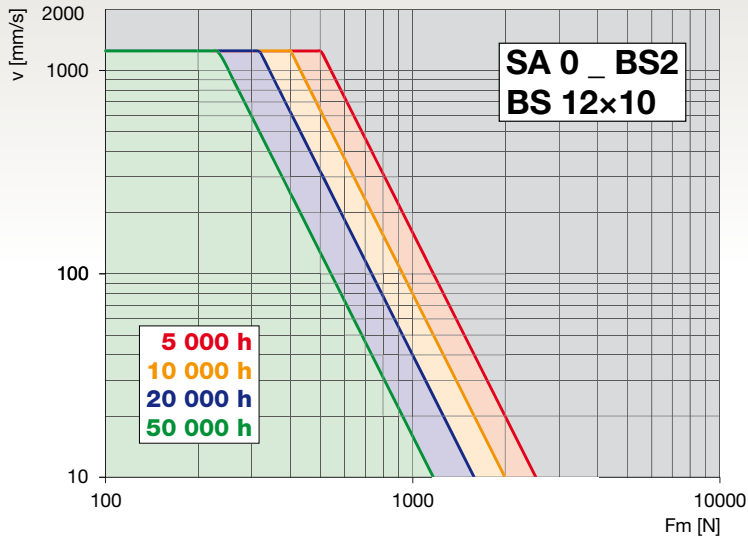

7.2.1
Size 0
Servoactuator

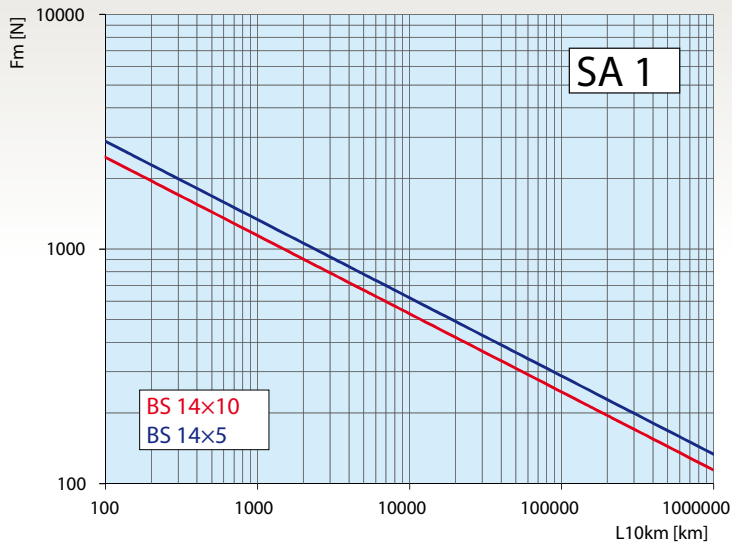

7.2.2
Size 1
Servoactuator

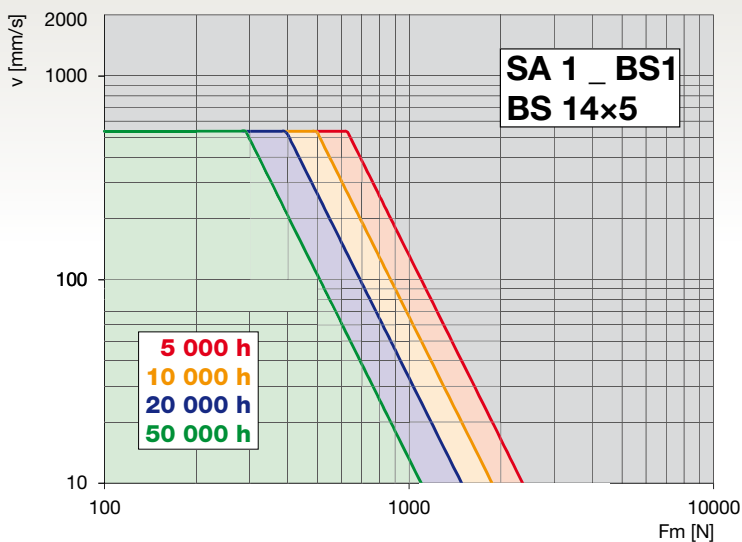

7.2.2
Size 1
Servoactuator

7.2 Ball screw life

7.2.2
Size 1
Servoactuator

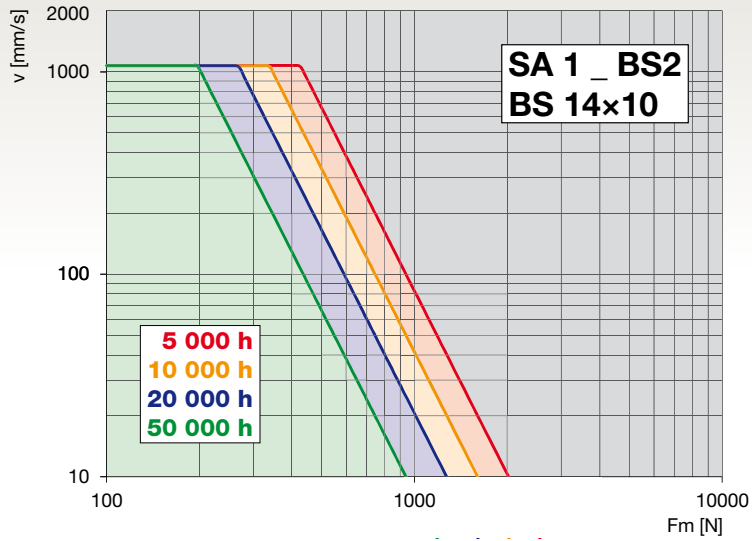

7.2.3
Size 2
Servoactuator

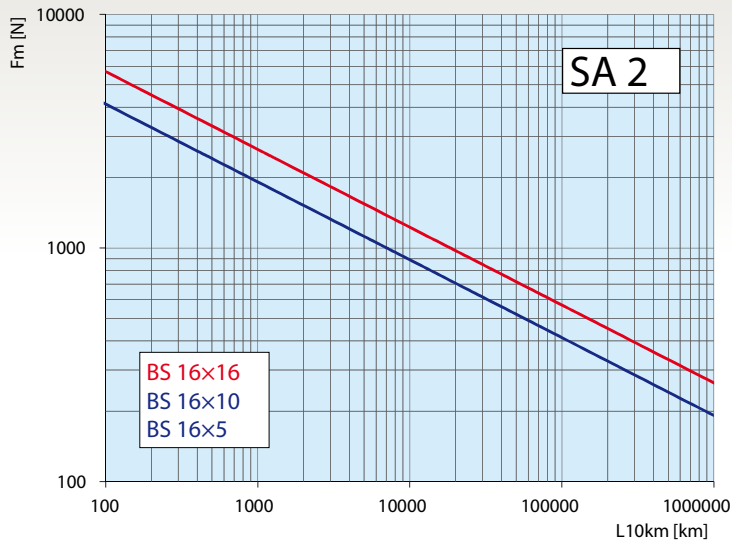

7.2.3
Size 2
Servoactuator

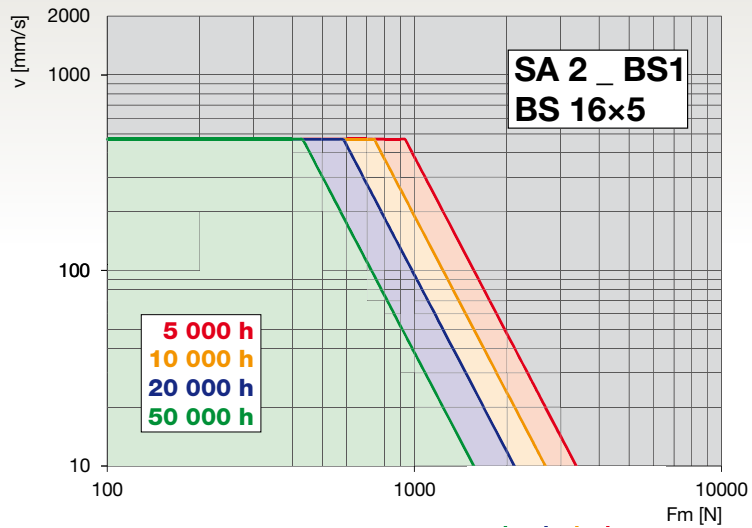

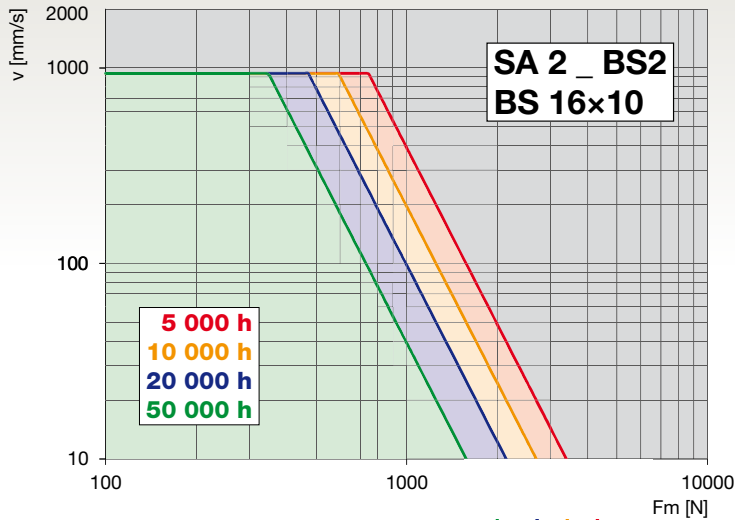

7.2.3
Size 2
Servoactuator

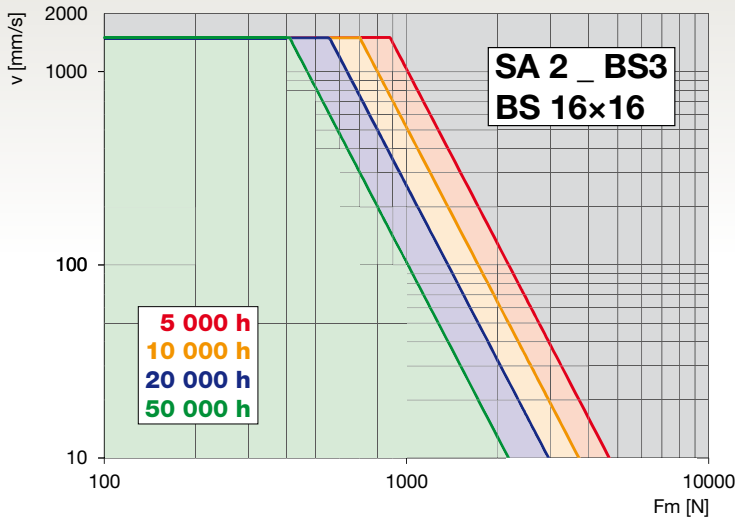

7.2.3
Size 2
Servoactuator

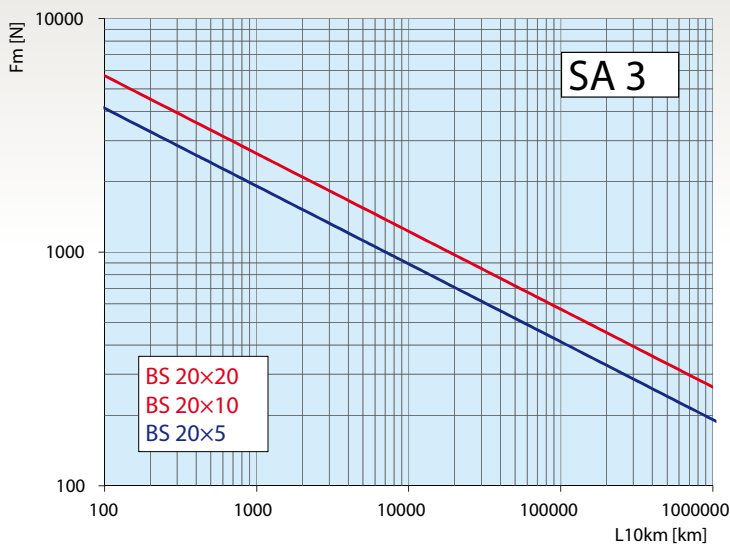

7.2.4
Size 3
Servoactuator

7.2 Ball screw life

7.2.4
Size 3
Servoactuator

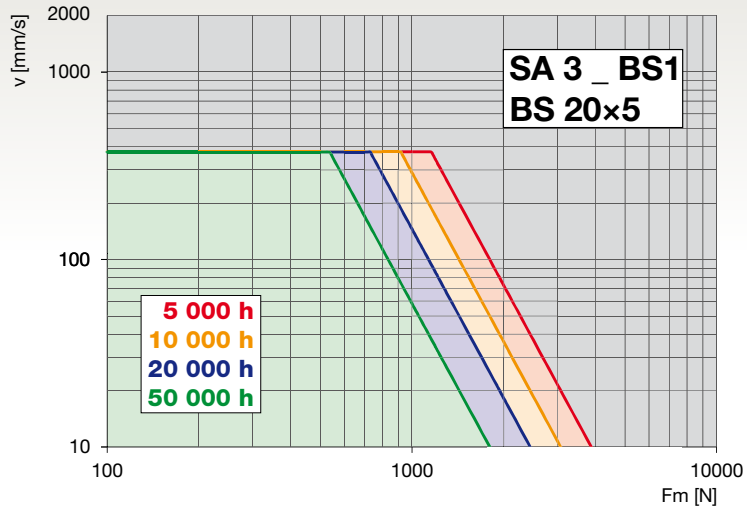

7.2.4
Size 3
Servoactuator

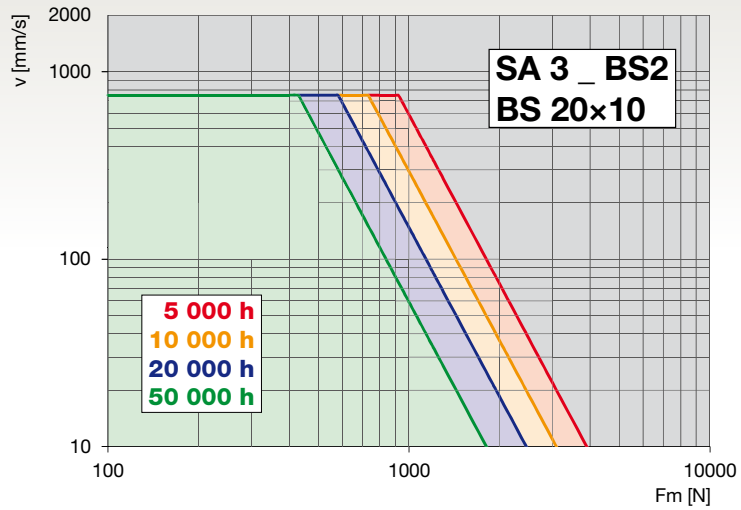

7.2.4
Size 3
Servoactuator

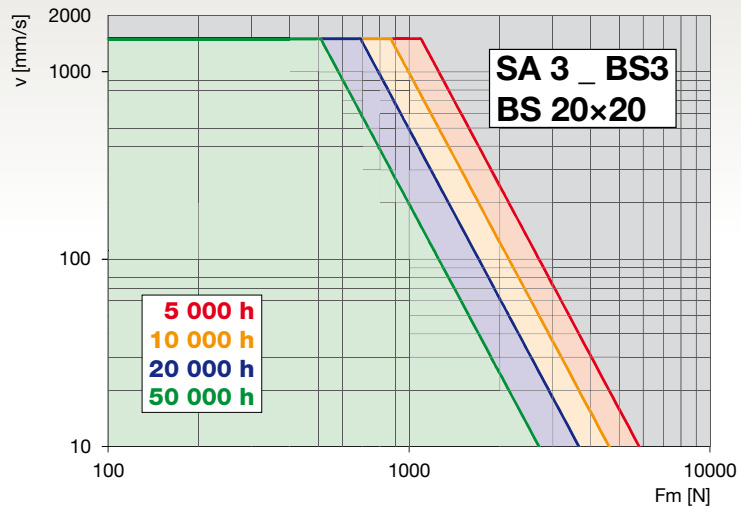

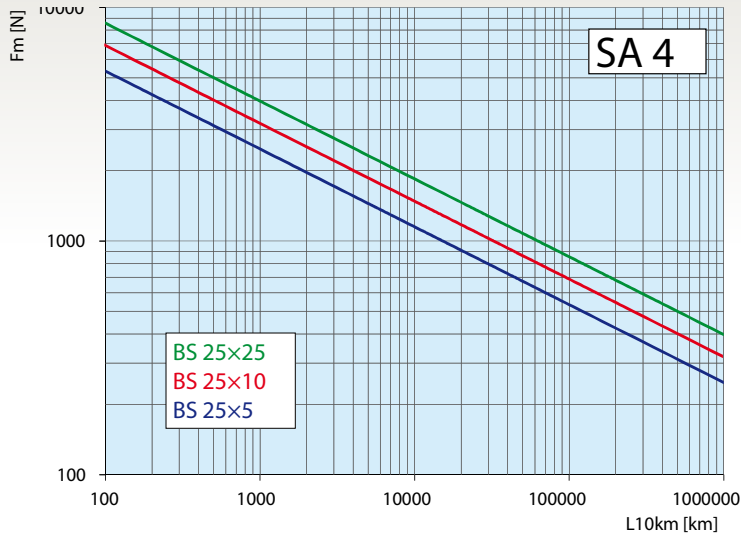

7.2.5
Size 4
Servoactuator

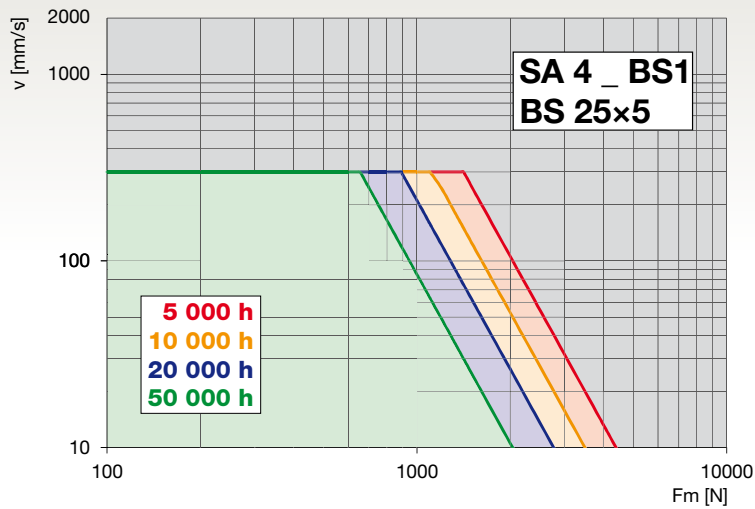

7.2.5
Size 4
Servoactuator

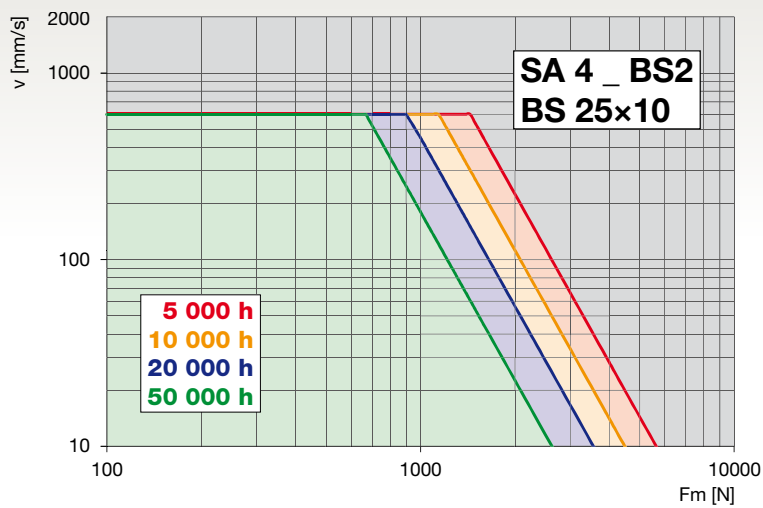

7.2.5
Size 4
Servoactuator

7.2 Ball screw life

7.2.5 Size 4 Servoactuator

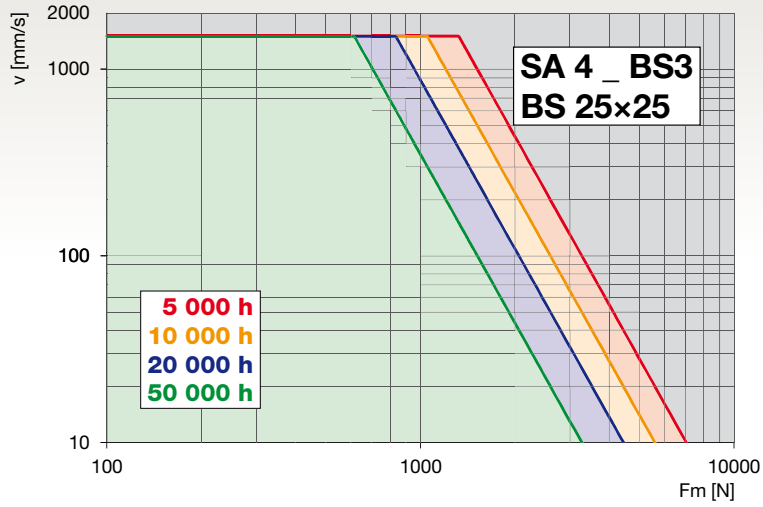

7.2.6 Size 5 Servoactuator

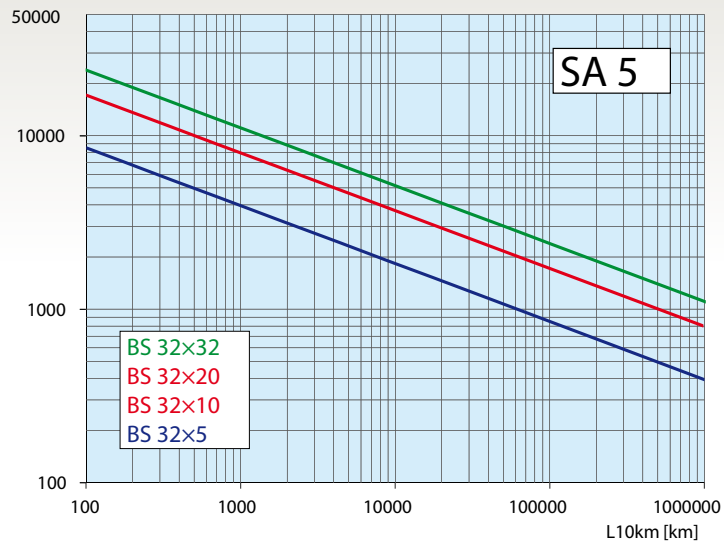

7.2.6 Size 5 Servoactuator

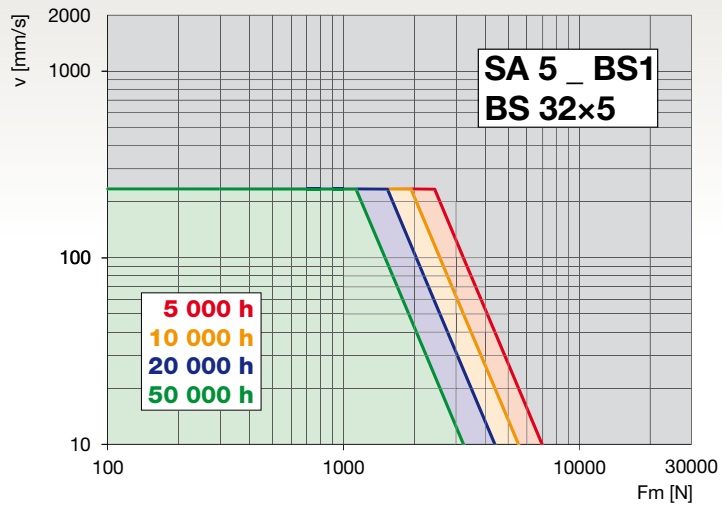

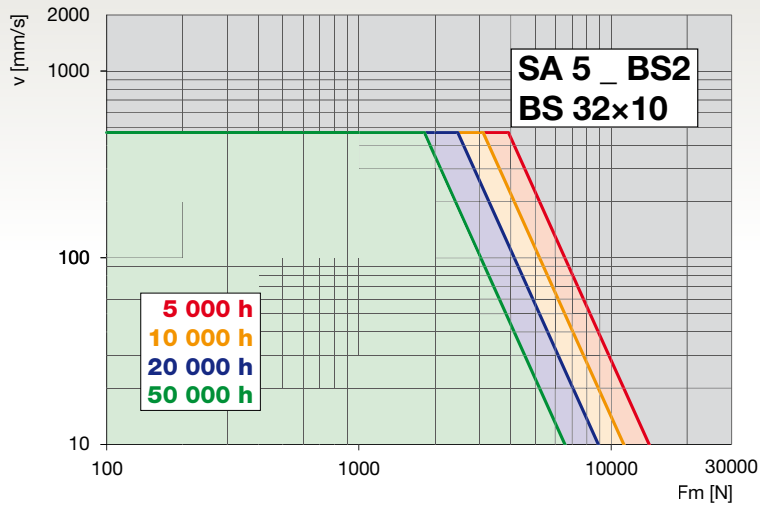

7.2.6
Size 5
Servoactuator

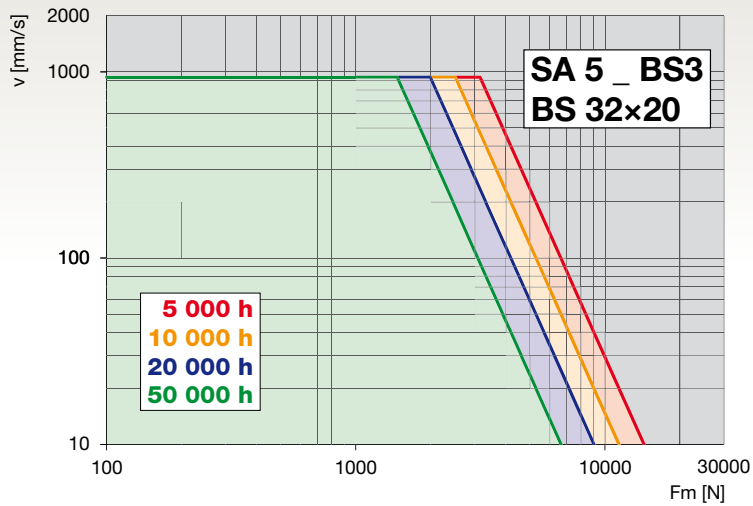

7.2.6
Size 5
Servoactuator

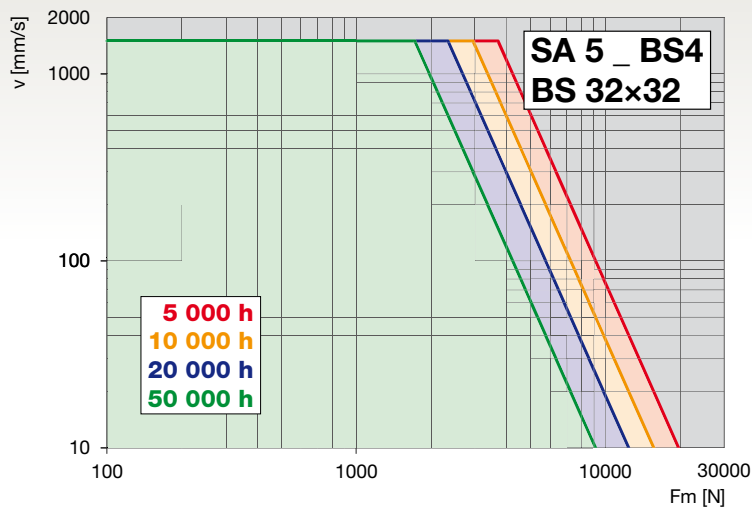

7.2.6
Size 5
Servoactuator

7.2 Ball screw life

7.2.7 Size 6 Servoactuator

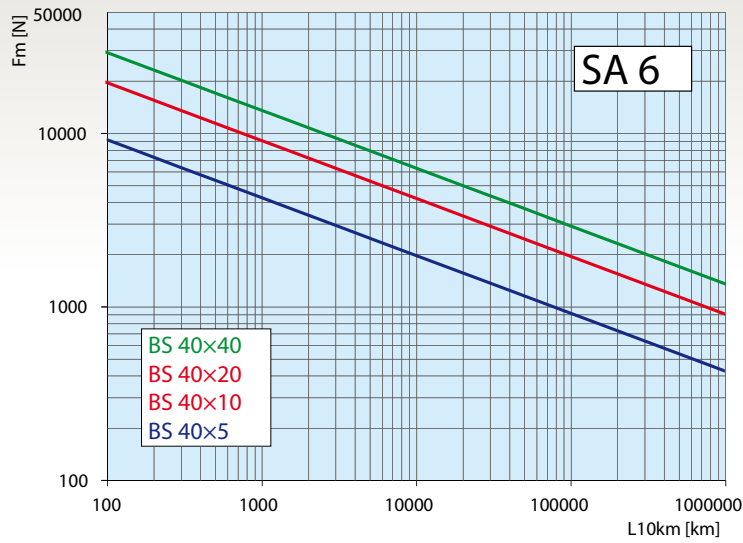

7.2.7 Size 6 Servoactuator

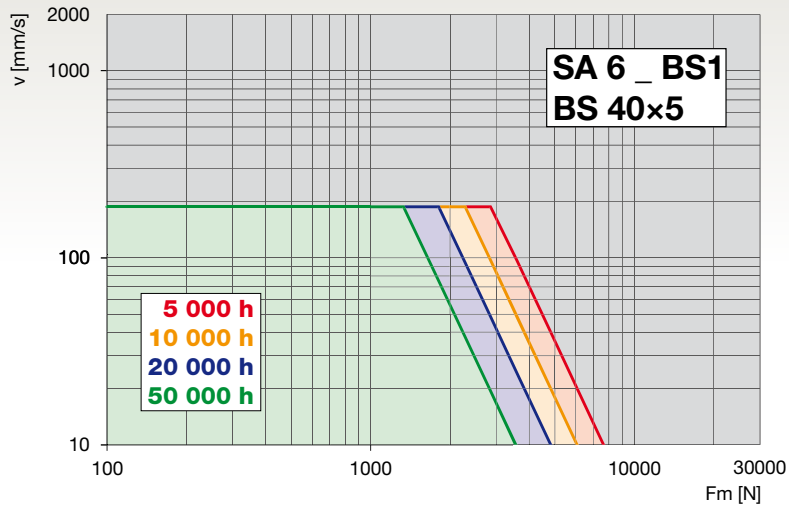

7.2.7 Size 6 Servoactuator

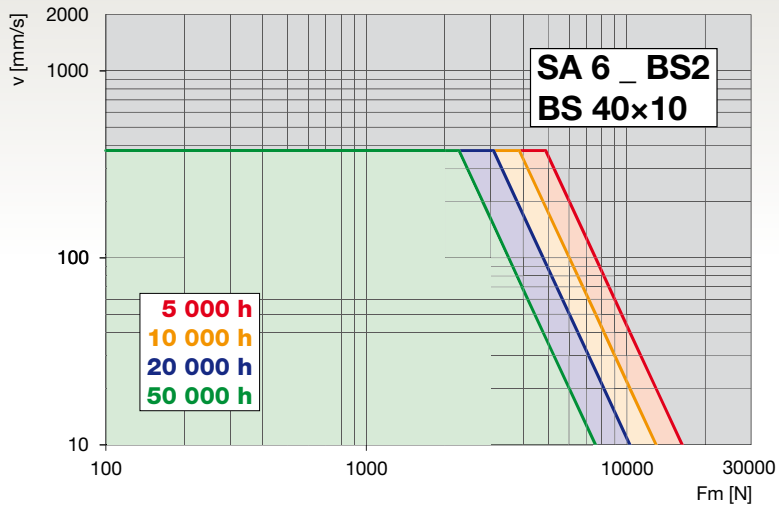

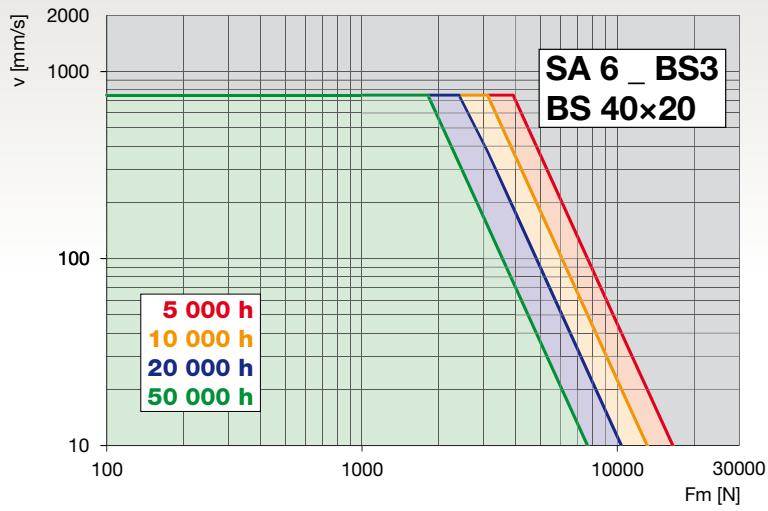

7.2.7
Size 6
Servoactuator

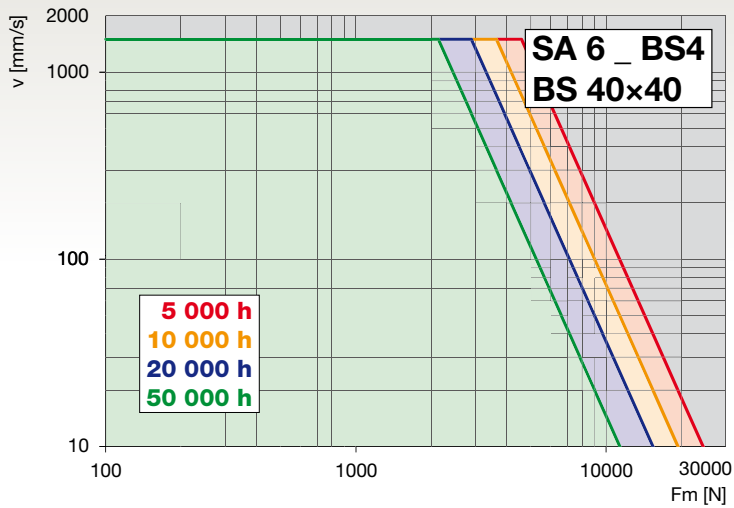

7.2.7
Size 6
Servoactuator

7.3 Buckling resistance

In case of push load (static or dynamic) applied on the servoactuator, the buckling resistance of the screw must be checked.

Usually, with standard stroke lengths as stated on our catalogue, it is not necessary to check the buckling resistance of the structure consisting of rod and outer tube, because it has moments of inertia higher than the screw's ones.

The screw mounted on the LINEARMECH linear servoactuator is supported by two angular bearings on motor side (or timing belt transmission side) and by a support on the opposite end. Therefore, the mechanical constraints will be a joint on one end and a hinge on the other end of the screw.

Considering a screw in such a condition to successfully undergo the Euler verifications of buckling (Euler III), we have:

$$F_{max} = \frac{6437.5 \cdot \pi^3 \cdot (d_0 - D_w)^4}{(C + x)^2 \cdot s.f.}$$

where:

F_{max} [N] = max. permissible push load

d_0 [mm] = ball screw nominal diameter

D_w [mm] = ball diameter

C [mm] = linear travel (stroke)

$s.f.$ = safety factor against buckling

(in following diagrams it is considered $s.f. = 3$)

x [mm] = additional factor to consider the real screw length

Values of the factor x depend on servoactuator size as stated in the following table:

SIZE	SA 0	SA 1	SA 2	SA 3	SA 4	SA 5	SA 6
Factor x	158.5	173.5	174.5	201.5	210	270	310

The values resulting from the above formula must be limited to the maximum load capacity: F_{max} in case of actuators SA Series, F_p in case of actuators SA IL or SA PD Series.

For easier and faster consultation, following diagrams show the limit conditions for each servoactuator size related to different loads F_{max} [N] and stroke length C [mm].

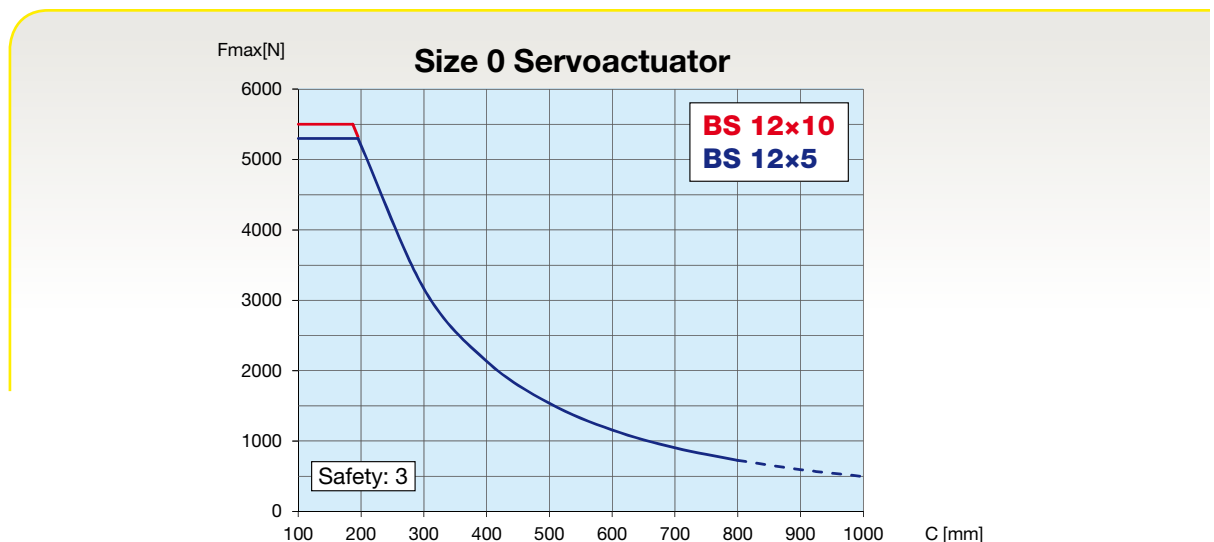

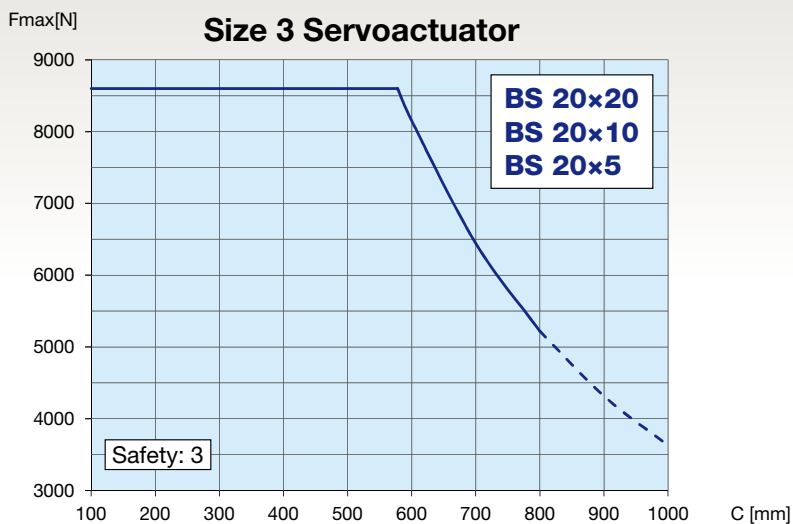
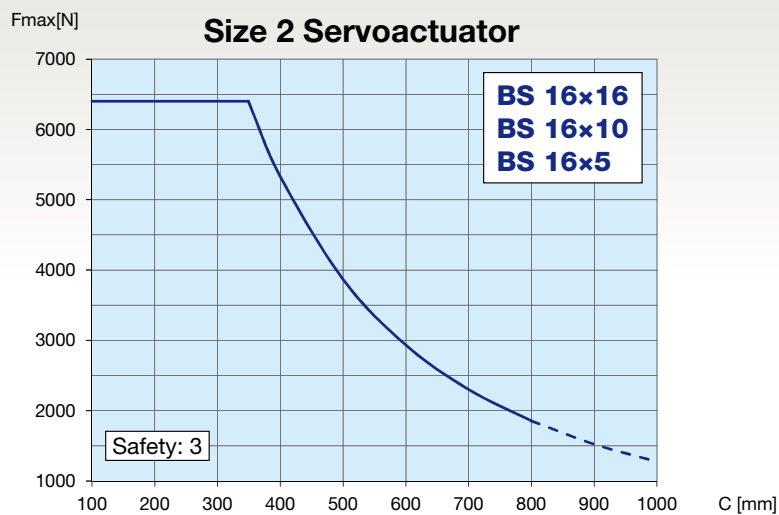
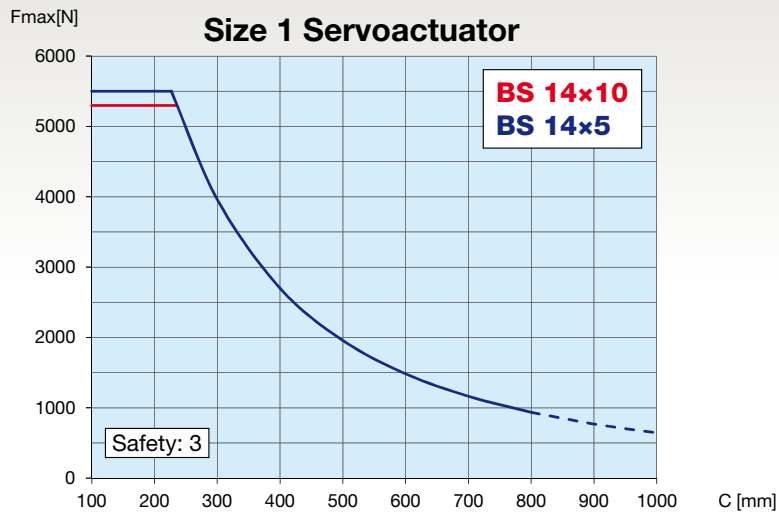

7.3 Buckling resistance

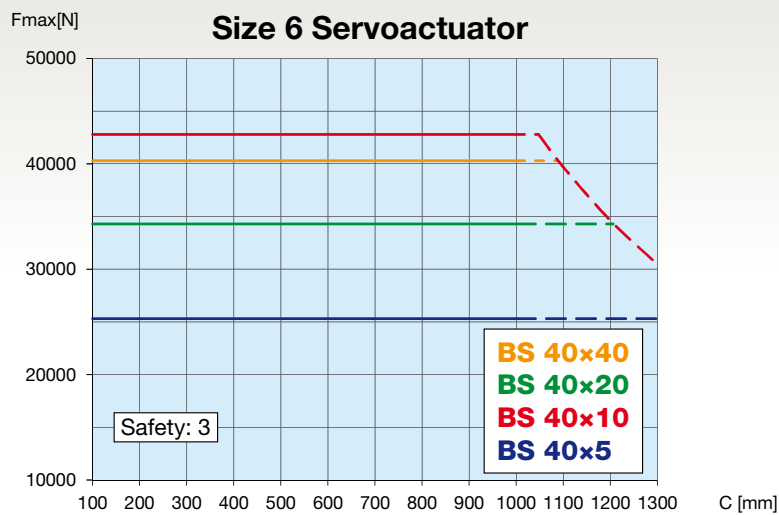
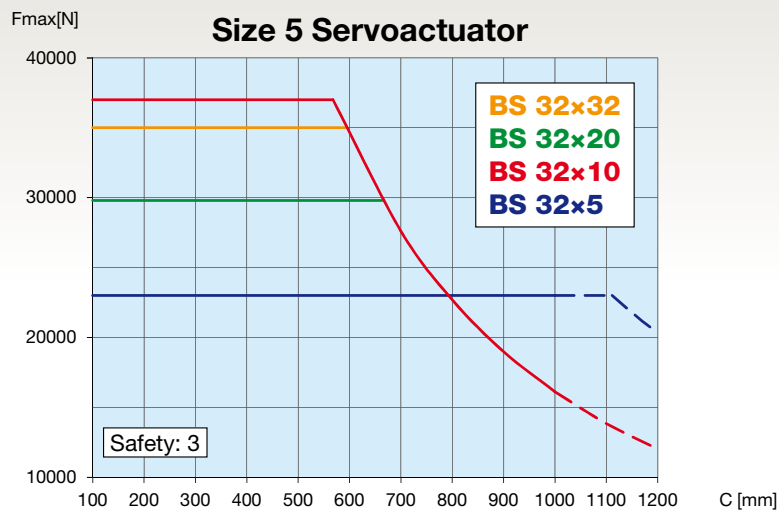
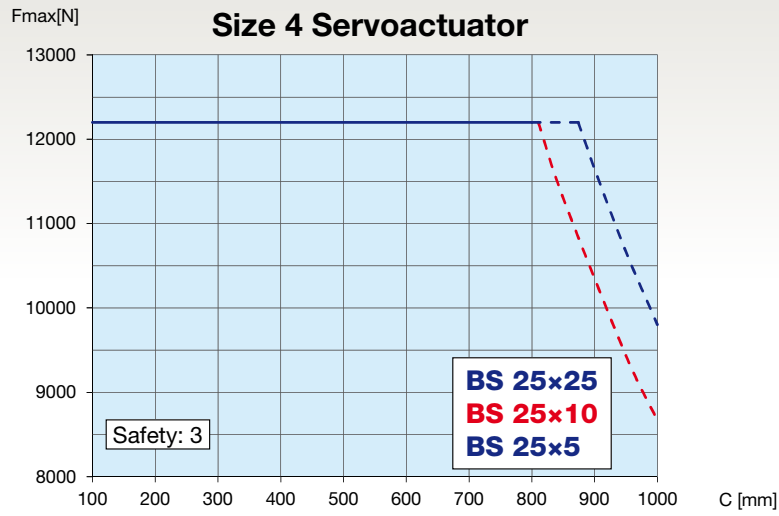

7.4 Critical speed

The rotating speed of the screw generates the rod linear movement. Therefore, the linear speed of the servoactuator, is limited by the following factors:

- a. External factors
(length, diameter and type of screw end supports)
- b. Internal factors
(balls material, geometry and material of all the recirculation elements)

The servoactuator linear speed should be calculated according to these two criteria. The lower one of these two values should be considered as the max. linear speed of the servoactuator.

a. Limits due to external factors

In order to ensure a proper working of the system and to prevent imbalances which could damage the ball screw, the rotating speed must not reach the critical level. Therefore, also the linear speed must be limited to the critical value.

The critical speed depends on the screw diameter, the type of screw end support and the length of the free ball screw.

The following formulae is used to calculate the max. permissible rotating speed. It restricts the rotating speed to 80 % of the critical value:

$$v_{max} = 0.251 \cdot 10^4 \cdot \frac{d_0 - D_w}{(C + x)^2} \cdot P_h$$

where:

v_{max} [m/s] = max. permissible linear speed

d_0 [mm] = ball screw nominal diameter

D_w [mm] = ball diameter

P_h [mm] = thread helix lead

C [mm] = linear travel (stroke)

x [mm] = additional factor to take into account the actual screw length

Factor x values depend on servoactuator size as stated in the following table. They are valid for the whole servoactuators range (SA Series, SA IL Series, SA PD Series):

SIZE	SA 0	SA 1	SA 2	SA 3	SA 4	SA 5	SA 6
Factor x	158.5	173.5	174.5	201.5	210	270	310

b. Limits due to internal factors

Depending on balls and screw material, geometry and material of all the recirculation elements and screw diameter, there is a specific limit of the max. rotating speed. The values related to each actuator model and size are stated in the specific performance tables.

NOTE: for motorized servoactuators (SA IL Series or SA PD Series), the speed limit is determined considering also the nominal rotating speed of the motor.

7.4 Critical speed

For easier and faster consultation, following diagrams show the limit conditions for each servoactuator size related to different linear speed v [mm/s] and stroke C [mm].

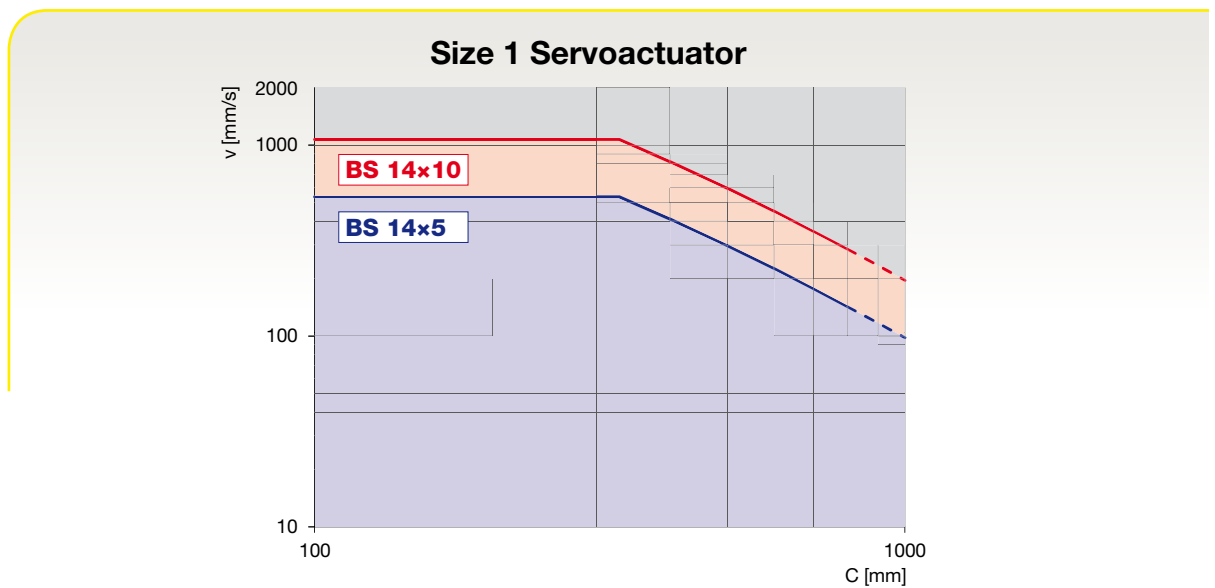
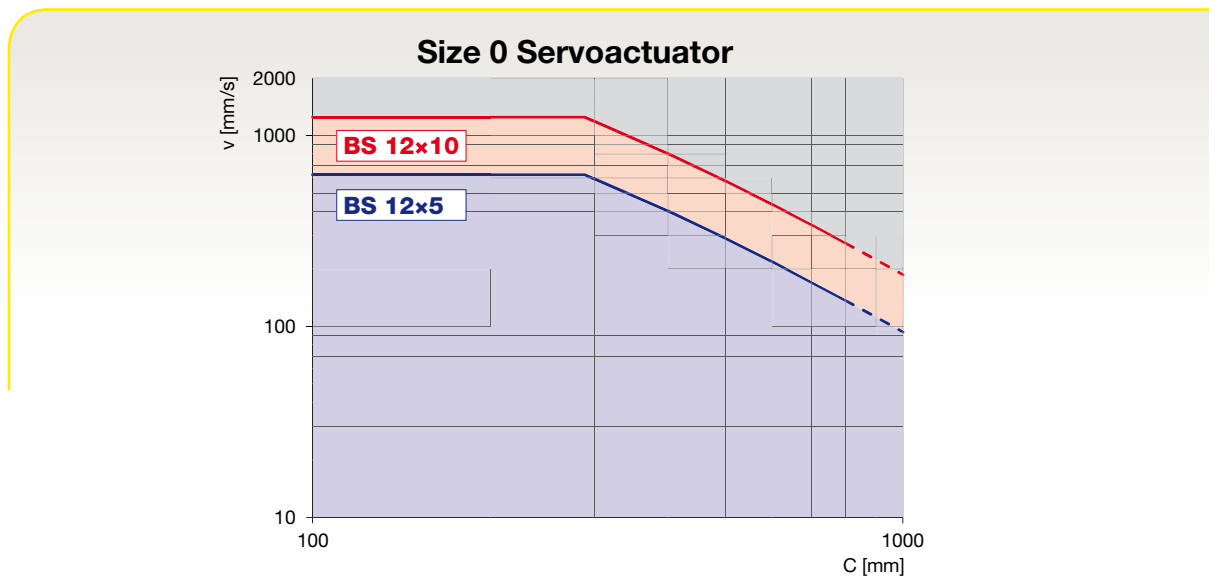

Size 2 Servoactuator

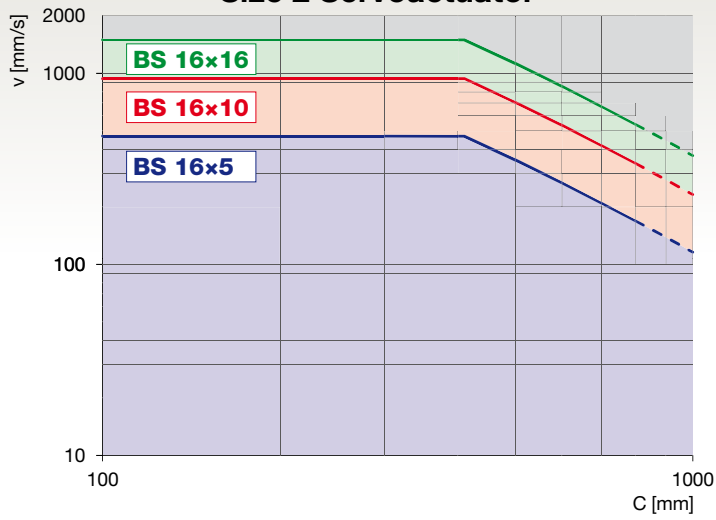

Size 3 Servoactuator

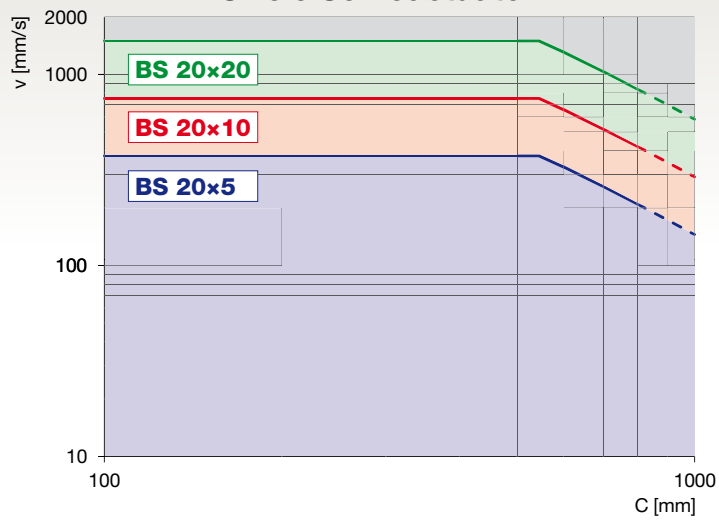

Size 4 Servoactuator

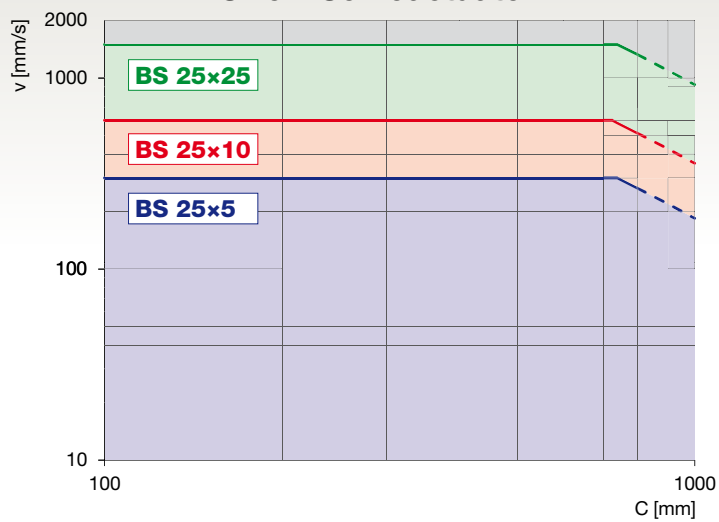

7.4 Critical speed

Size 5 Servoactuator

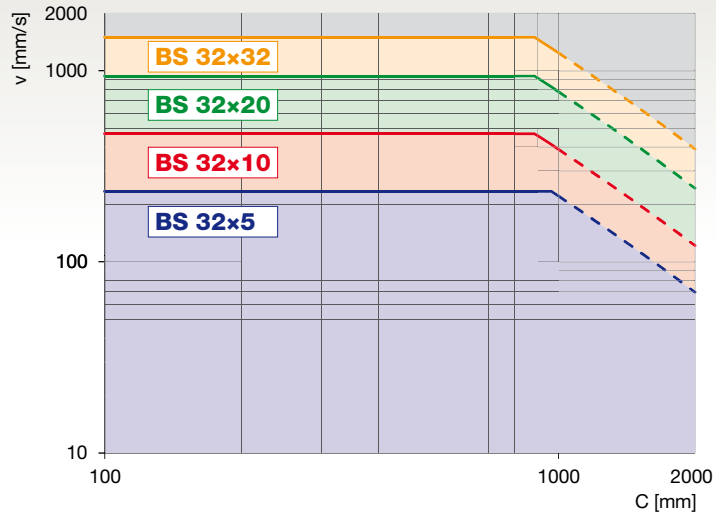

Size 6 Servoactuator

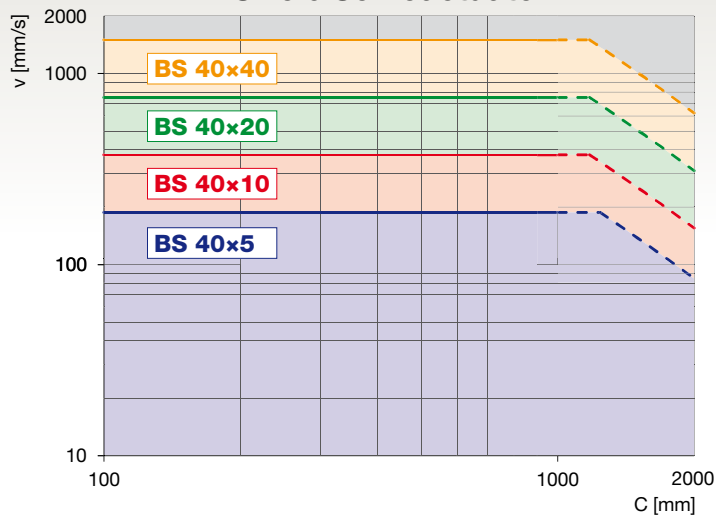

The following tables show the tolerance values T related to the acceptable positioning error for each rated stroke, that can occur using ball screws with accuracy grade IT7, according to ISO 3408 parameters. LINEARMECH, for its servoactuators with brushless servomotor, includes in this value even the positioning error due to the resolution/accuracy of the encoder/resolver.

The maximum positioning error for the entire stroke is:

$$e_M = \pm T$$

The standard axial backlash in ball nuts, with a variability from 20 up to 40 μm , isn't considered in this table. The positioning error can be affected by axial backlash in case of reversal of the axial load on the actuator. LINEARMECH can anyway supply zero-backlash nuts or preloaded nuts in order to avoid or limit this kind of problem. When a better positioning accuracy is needed, LINEARMECH can provide ball screw with accuracy grade IT5 or IT3. For further details about positioning errors, please contact our Technical support.

Tolerance values related to the acceptable positioning error T [μm]										
Stroke [mm]	100	200	300	400	500	600	700	800	900	1000
SA 0	43	61	76	-	-	-	-	-	-	-
SA 1	43	61	76	86	-	-	-	-	-	-
SA 2	43	61	76	86	93	100	-	-	-	-
SA 3	43	61	76	86	93	100	105	115	-	-
SA 4	43	61	76	86	93	100	105	115	-	-
SA 5	43	61	76	86	93	100	105	115	120	129
SA 6	43	61	76	86	93	100	105	115	120	129
SA 0 IL (BS1)	46	64	79	-	-	-	-	-	-	-
SA 0 IL (BS2)	48	66	81	-	-	-	-	-	-	-
SA 1 IL (BS1)	46	64	79	88	-	-	-	-	-	-
SA 1 IL (BS2)	48	66	81	91	-	-	-	-	-	-
SA 2 IL (BS1)	46	64	79	88	95	103	-	-	-	-
SA 2 IL (BS2)	48	66	81	91	98	105	-	-	-	-
SA 2 IL (BS3)	51	69	84	94	101	108	-	-	-	-
SA 3 IL (BS1)	46	64	79	88	95	103	108	118	-	-
SA 3 IL (BS2)	48	66	81	91	98	105	110	120	-	-
SA 3 IL (BS3)	53	71	86	96	103	110	115	125	-	-
SA 4 IL (BS1)	46	64	79	88	95	103	108	118	-	-
SA 4 IL (BS2)	48	66	81	91	98	105	110	120	-	-
SA 4 IL (BS3)	56	74	89	98	105	113	118	128	-	-
SA 5 IL (BS1)	46	64	79	88	95	103	108	118	122	131
SA 5 IL (BS2)	48	66	81	91	98	105	110	120	125	134
SA 5 IL (BS3)	53	71	86	96	103	110	115	125	130	139
SA 5 IL (BS4)	59	77	92	102	109	116	121	131	136	145
SA 6 IL (BS1)	46	64	79	88	95	103	108	118	122	131
SA 6 IL (BS2)	48	66	81	91	98	105	110	120	125	134
SA 6 IL (BS3)	53	71	86	96	103	110	115	125	130	139
SA 6 IL (BS4)	63	81	96	106	113	120	125	135	140	149

Stroke [mm]	Tolerance values related to the acceptable positioning error T [μm]									
	100	200	300	400	500	600	700	800	900	1000
SA 0 PD RV (BS1)	46	64	79	-	-	-	-	-	-	-
SA 0 PD RV (BS2)	48	66	81	-	-	-	-	-	-	-
SA 1 PD RV (BS1)	46	64	79	88	-	-	-	-	-	-
SA 1 PD RV (BS2)	48	66	81	91	-	-	-	-	-	-
SA 2 PD RV (BS1)	46	64	79	88	95	103	-	-	-	-
SA 2 PD RV (BS2)	48	66	81	91	98	105	-	-	-	-
SA 2 PD RV (BS3)	51	69	84	94	101	108	-	-	-	-
SA 3 PD RV (BS1)	45	63	78	88	95	102	107	117	-	-
SA 3 PD RV (BS2)	48	66	81	90	97	105	110	120	-	-
SA 3 PD RV (BS3)	52	70	85	95	102	109	114	124	-	-
SA 3 PD RN (BS1)	45	63	78	87	94	102	107	117	-	-
SA 3 PD RN (BS2)	47	65	80	89	96	104	109	119	-	-
SA 3 PD RN (BS3)	51	69	84	93	100	108	113	123	-	-
SA 4 PD RV (BS1)	45	63	78	88	95	102	107	117	-	-
SA 4 PD RV (BS2)	48	66	81	90	97	105	110	120	-	-
SA 4 PD RV (BS3)	54	72	87	97	104	111	116	126	-	-
SA 4 PD RN (BS1)	45	63	78	87	94	102	107	117	-	-
SA 4 PD RN (BS2)	47	65	80	89	96	104	109	119	-	-
SA 4 PD RN (BS3)	52	70	85	95	102	109	114	124	-	-
SA 5 PD RV (BS1)	46	64	79	88	95	103	108	118	122	131
SA 5 PD RV (BS2)	48	66	81	91	98	105	110	120	125	134
SA 5 PD RV (BS3)	53	71	86	96	103	110	115	125	130	139
SA 5 PD RV (BS4)	59	77	92	102	109	116	121	131	136	145
SA 5 PD RN (BS1)	45	63	78	87	94	102	107	117	121	130
SA 5 PD RN (BS2)	46	64	79	89	96	103	108	118	123	132
SA 5 PD RN (BS3)	50	68	83	92	99	107	112	122	126	135
SA 5 PD RN (BS4)	54	72	87	96	103	111	116	126	130	139
SA 6 PD RV (BS1)	46	64	79	88	95	103	108	118	122	131
SA 6 PD RV (BS2)	48	66	81	91	98	105	110	120	125	134
SA 6 PD RV (BS3)	53	71	86	96	103	110	115	125	130	139
SA 6 PD RV (BS4)	63	81	96	106	113	120	125	135	140	149
SA 6 PD RN (BS1)	45	63	78	87	94	102	107	117	121	130
SA 6 PD RN (BS2)	46	64	79	89	96	103	108	118	123	132
SA 6 PD RN (BS3)	50	68	83	92	99	107	112	122	126	135
SA 6 PD RN (BS4)	56	74	89	99	106	113	118	128	133	142

LINEARMECH servoactuators are supplied with lubricant included.

Standard lubricant for ball bearings and ball screw for all servoactuator sizes is: **LUBCON Thermoplex ALN 1001**.

Standard lubricant is suitable for the whole speed range performable by the servoactuators, while operating with ambient temperature (10 ... 40)°C. In case of different operating temperature, we recommend to contact LINEARMECH support to evaluate the use of different lubricant.

Ball bearings are lubricated for life.

Ball nut must be periodically greased: for a proper lubrication, please refer to the **User and Maintenance Manual** supplied with the actuator to define the right maintenance scheduling, lubricant type and quantity.

LINEARMECH linear servoactuators have a specific lubrication system, as described in Chapter 2.2-2.3, pages 6-8. It is recommended to use LUB ferrule lubricators, specific for concave grease nipples.

To access to the grease nipple located on the nut, it is necessary to put the actuator in its completely retracted position until it stops against the shock absorber. Then open it for a linear distance L , as shown on the image below, to align the nut grease nipple to the hole on the outer tube.

Now it is possible to remove the cap on the hole and put in the LUB ferrule lubricator to grease the nut. The opening stroke length L is :

$$L = \frac{C}{2} + A$$

where:

L [mm] = linear distance for the lubrication

C [mm] = linear travel (stroke) of the servoactuator

A = constant value specific for each size (see following table)

SIZE	SA 0	SA 1	SA 2	SA 3	SA 4	SA 5	SA 6
A	4.5	2.5	3	7	6	-3.5	-5.5

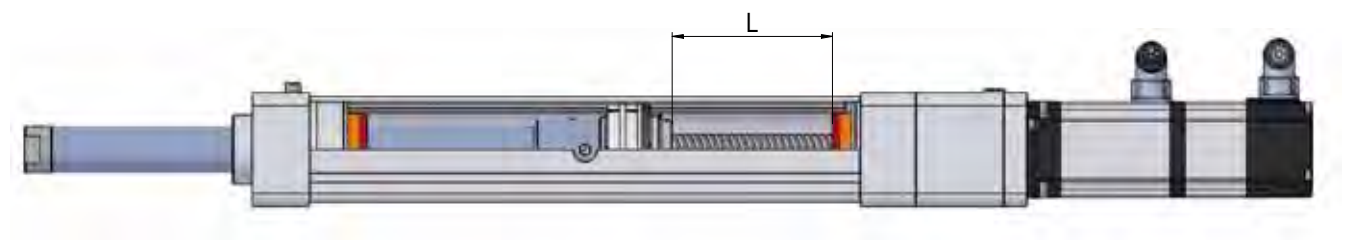

Servoactuators have two or more slots on the extruded aluminium profile to fit the stroke end switches. Profile shape in compliance with ISO 15552 standards. The following drawings show these arrangements.

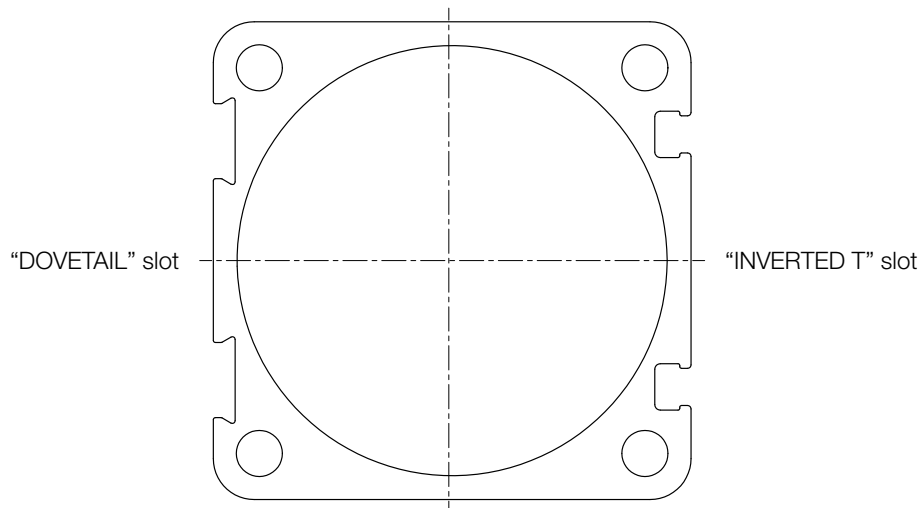

Both types of sensors can be fitted inside their slot from the top.

The **sensor for "dovetail" slot** FTV F83E2R + FA52 (**ordering code FTV**) consists of two elements held together by a screw: the sensor FTV F83E2R and the fixing bracket FA52. After fitting the sensor and the bracket from the top, it is necessary to align them and partially screw the fixing screw. The group can then be moved along the slot in the desired position and finally locked by tightening the screw.

The **sensor for "inverted T" slot** FPH F86E2T (**ordering code FPH**) is fitted from the top; when in the required position, they can be fixed by turning clockwise the screw until stroke end.

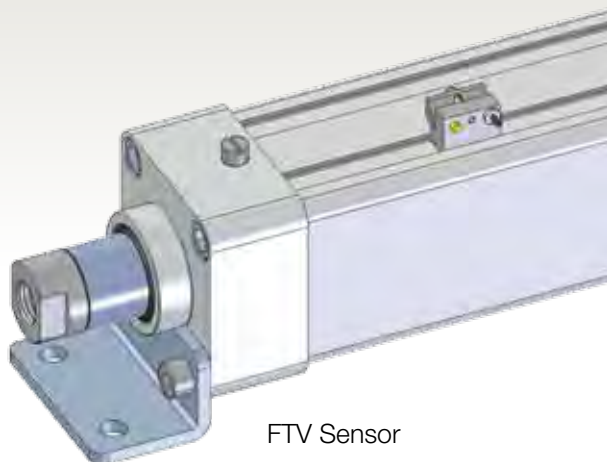

FTV Sensor

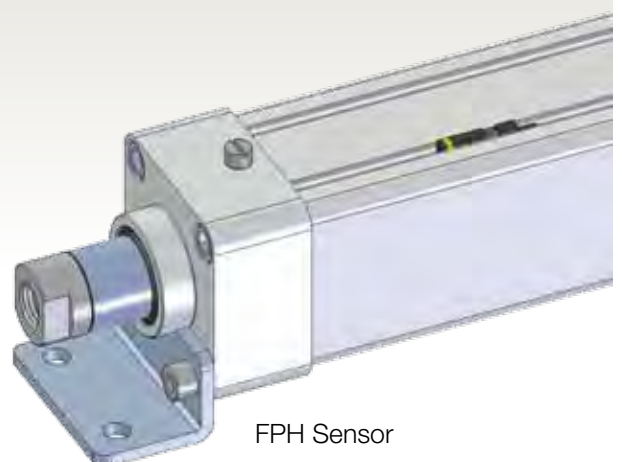

FPH Sensor

10.1 Technical data

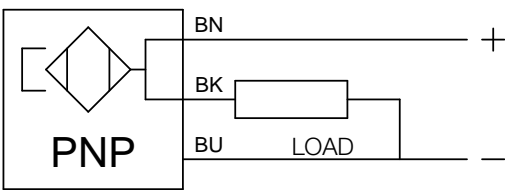
	Unit of measure	FTV F83E2R + FA 52 (codice FTV)	FPH F86E2T (codice FPH)
Slot shape	–	dovetail	inverted T
Contact	–	NO	NO
Output signal	–	PNP	PNP
Circuit	–		
Power supply LED	–	n.a.	n.a.
Signal LED	–	YES	YES
Power supply	V dc	10 ... 30	10 ... 30
Voltage drop @ 10 mA	V	0.8	0.8
Max. current	mA	200	200
Max. power	W	6	6
Switching delay ON	ms	0.2	0.2
Switching delay OFF	ms	20 (!)	0.1
Overcurrent protection	–	YES	n.a.
Power supply inverse polarity protection	–	YES	YES
Short circuit protection	–	YES	n.a.
Operating temperature	°C	- 20 ... + 70	- 20 ... + 70
Accuracy grade	–	IP 67	IP 68
Material	–	ZA4	PA
Cable	–	PVC, black, 3 × 0.25 mm ² L = 3 m	PUR, black, 3 × 0.25 mm ² L = 3 m

NOTE: sensors are supplied without connector.

(!) - the switching delay is obtained electronically; it enables the signal readout at high speed conditions

LINEARMECH Brushless Servomotors BM Series are produced according to the latest state-of-the-art technology to improve the specific torque and its linear erogation.

The high efficiency servomotors BM Series by Linearmech are made using **“Segmented Lamination Stator Technology”**. This technology can pack higher torque and power density into the same-sized motor. It also allows the highest slot fill of the stator winding and the motor to run cooler, potentially extending its operational life.

Brushless servomotors BM Series have been designed for continuous working with natural convection cooling, without external cooling devices. The heat is mainly generated in the stator winding and it is dissipated through the motor external body thanks to the excellent mechanical and thermal coupling between these two parts.



11.1 General data

Motor type:	brushless with sinusoidal back-EMF (synchronous, permanent magnets)
Cooling:	natural convection
Mounting:	IM B5
Magnets material:	NeFeB
Insulation class:	F (overheating on windings 100 K with ambient temperature 40°C and safety margin 15°C)
Protection:	motore body IP 54 motore shaft IP 44 standard, IP 54 with lubricant seal
Operating temperature:	(0 ... + 40)°C
Ambient storage temperature:	(- 10 ... + 60)°C
Humidity:	max. 85 % without condensation
Operating altitude:	< 1000 m ASL (for higher altitude a degrading factor must be applied)
Thermal protection:	optional: PTC, PTO or KTY
Motor feedback:	optical encoder, LINE-DRIVER, 2000 ppr (standard) resolver, 1 pole pairs 7 V rms, 10 kHz (optional) BISS absolute multiturn encoder (optional)
Holding brake:	optional, 24 V dc power supply
Balance quality grade:	G 2.5 (standard) according to IEC 1940-1
Reference standards:	IEC 60034-1, IEC 60034-5, IEC 60034-6, IEC 60034-7, IEC 60034-11, ISO 1940-1
Marked:	CE

11.2 Construction technology

The STATOR of LinearMech brushless servomotors is made according to the “**Segmented Lamination Stator Technology**” to optimize the use of copper. In details, the advantages and benefits of this construction technology are:

- **Greater fill factor:** by winding every tooth individually, segmented lamination stator technology allow higher slot fill compared to more traditional brushless dc motor stators of equal size. With traditional windings, the slot fill is about 30% of the total space. Using the segmented lamination stator technology it's possible to reach 40% and more.
- **Reduced length of end windings:** the end windings do not provide additional power or torque. They only connect “active” electrical conductors from one slot to another. By carrying current, the end windings are naturally affected by losses of electrical power. By reducing their length, the motor efficiency increases.

The segmented lamination stator technology lead to a considerable increase of performances in servomotors, both in torque and efficiency, than motors produced with traditional technology.

Peculiar magnets geometry together with a specific magnets protection create a robust ROTOR structure, minimizing the cogging effect.

- **Magnets geometry:** through FEM software we defined the optimal magnets shape to minimize the cogging effect and the harmonic distortion of the BEMF generated by the motor. The result is a motor with very low cogging torque and a very low torque ripple.
- **Stainless steel magnets protection:** permanent magnets used in brushless servomotors are rare-earth magnets (NdFeB) with great magnetic properties in terms of “energy density”. Unfortunately they can be subject to corrosive attack if exposed to particularly aggressive environments, as they are obtained by sintering process. Magnets are also fixed on the motor shaft and they are subject to centrifugal forces and mutual attraction forces while rotating. To ensure the mechanical fixing of magnets and their insulation from the outside, a retaining system based on stainless steel bushes placed in each rotor of the BM series is applied.

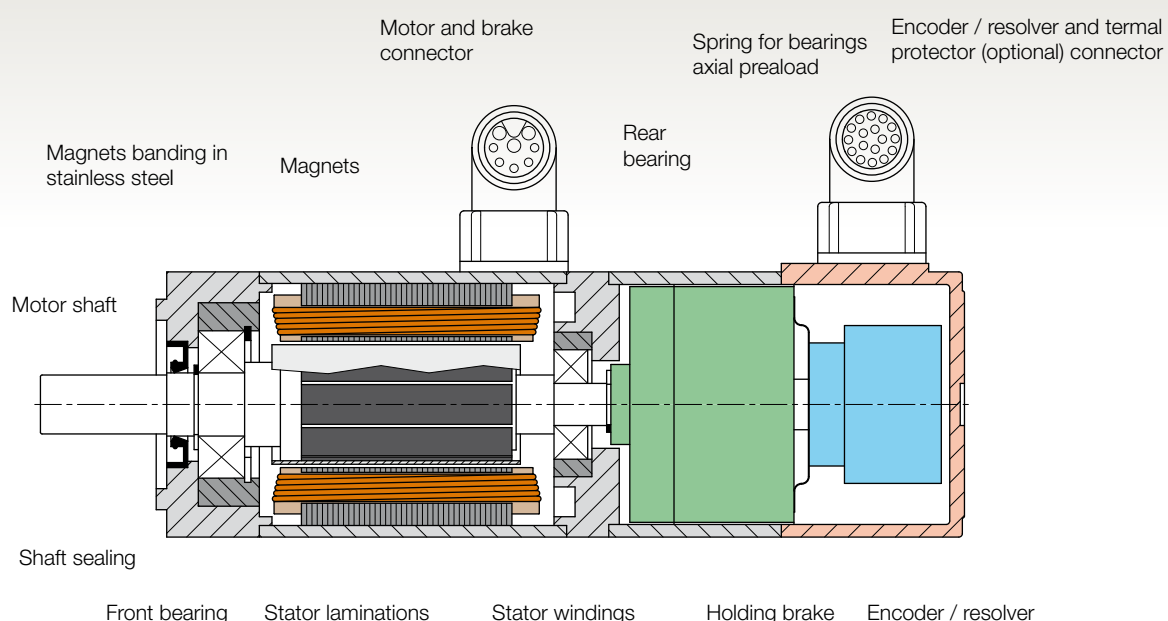

11.3 Technical data

Servoactuator size		SA 0		SA 1
Servomotor size		BM 45 L - 30		
Drive rated voltage	U_{nom} [V]	24 V dc	48 V dc	230 V dc
Stall torque	$T_{0,100K}$ [Nm]	0.35		
Continuous rated torque	$T_{nom,100K}$ [Nm]	0.32		
Peak torque	T_p [Nm]	1.05		
Rated speed	n_{nom} [rpm]	3000		
Max. speed	n_{max} [rpm]	4000		
Number of poles		8		
Stall current	$I_{0,100K}$ [A]	7.4 (!)	3.8 (!)	1.25
Peak current	I_p [A]	24.4 (!)	12.5 (!)	3.95
Voltage constant	k_E [V/1000 rpm]	5 (!)	8.9 (!)	17.2
Torque constant	k_T [Nm/A]	0.047 (!)	0.09 (!)	0.28
Thermal time constant	t_{th} [min]	12		
Winding resistance	R_{ph} [Ω]	0.38	1.4	9.7
Winding inductance	L_D [mH]	0.69	2.4	16.7
Electric time constant	t_{el} [ms]	1.8	1.7	1.7
Moment of inertia (without brake)	J_{motore} [kg \times m ²]	0.091 \times 10 ⁻⁴		
Moment of inertia (with brake)	$J_{motore BR}$ [kg \times m ²]	0.092 \times 10 ⁻⁴		
Rated braking torque	T_{BR} [Nm]	0.8		
Brake supply voltage	U_{BR} [V]	24 V dc		
Brake power	P_{BR} [W]	12.8 ^{+ 5 %}		
Brake engagement delay time	t_{BR} [ms]	40 ^{- 10 %}		
Brake disengagement delay time	t_{-BR} [ms]	7		
Permissible radial load on motor shaft	F_R [N]	150		
Permissible axial load on motor shaft	F_N [N]	50		
Mass without brake / mass with brake	m [kg]	0.9 / 1.2		

(!) - DC values refer to trapezoidal commutation

NOTE: Available, upon request, special windings for higher nominal rated speed up to 6000 rpm. Contact LINEARMECH technical support for more information.

11.3 Technical data

SA 2			SA 3			Servoactuator size	
BM 63 S - 30			BM 63 L - 30			Servomotor size	
24 V dc	48 V dc	230 V ac	24 V dc (¹)	48 V dc	230 V ac	[V]	U_{nom} Drive rated voltage
0.7			1.35			[Nm]	$T_{0, 100K}$ Stall torque
0.6			1.3			[Nm]	$T_{nom, 100K}$ Continuous rated torque
2.1			4.2			[Nm]	T_p Peak torque
3000			3000			[rpm]	n_{nom} Rated speed
4000			4000			[rpm]	n_{max} Max. speed
8			8				Number of poles
15.9 (¹)	7.7 (¹)	0.98	35 (¹)	15.7 (¹)	2.1	[A]	$I_{0, 100K}$ Stall current
50.8 (¹)	25.8 (¹)	3.7	115 (¹)	53 (¹)	7.1	[A]	I_p Peak current
4.7 (¹)	9.7 (¹)	41	4.3 (¹)	9.4 (¹)	43	[V/1000 rpm]	k_E Voltage constant
0.044 (¹)	0.09 (¹)	0.67	0.04 (¹)	0.089 (¹)	0.71	[Nm/A]	k_T Torque constant
15			15			[min]	t_{th} Thermal time constant
0.13	0.5	17.4	0.09	0.2	7.1	[Ω]	R_{ph} Winding resistance
0.39	1.5	53	0.17	0.8	30	[mH]	L_D Winding inductance
3	3	3	1.9	4.2	4.2	[ms]	t_{el} Electric time constant
0.156×10^{-4}			0.272×10^{-4}			[kg × m²]	J_{motore} Moment of inertia (without brake)
0.174×10^{-4}			0.290×10^{-4}			[kg × m²]	$J_{motore BR}$ Moment of inertia (with brake)
2.5			2.5			[Nm]	T_{BR} Rated braking torque
24 V dc			24 V dc			[V]	U_{BR} Brake supply voltage
13.3 ^{+ 5 %}			13.3 ^{+ 5 %}			[W]	P_{BR} Brake power
40 ^{- 10 %}			40 ^{- 10 %}			[ms]	t_{BR} Brake engagement delay time
7			7			[ms]	t_{BR} Brake disengagement delay time
230			230			[N]	F_R Permissible radial load on motor shaft
70			70			[N]	F_N Permissible axial load on motor shaft
1.25 / 1.90			1.85 / 2.50			[kg]	m Mass without brake / mass with brake

(¹) - DC values refer to trapezoidal commutation

(²) - only intermittent service S3 25 % over 10 min

11.3 Technical data

Servoactuator size			SA 4		SA 5	
Servomotor size			BM 82 L - 30		BM 102 S - 30	
Drive rated voltage	U_{nom}	[V]	230 V ac	400 V ac	230 V ac	400 V ac
Stall torque	$T_{0, 100K}$	[Nm]	2.9		5.2	
Continuous rated torque	$T_{nom, 100K}$	[Nm]	2.5		4.1	
Peak torque	T_p	[Nm]	9.0		15.0	
Rated speed	n_{nom}	[rpm]	3000		3000	
Max. speed	n_{max}	[rpm]	4000		4000	
Number of poles			8		8	
Stall current	$I_{0, 100K}$	[A]	4.6	2.3	6.5	3.5
Peak current	I_p	[A]	14.7	7.4	26.0	14.0
Voltage constant	k_E	[V/1000 rpm]	39.5	78.0	48.6	90.0
Torque constant	k_T	[Nm/A]	0.64	1.28	0.8	1.48
Thermal time constant	t_{th}	[min]	16		35	
Winding resistance	R_{ph}	[Ω]	1.5	6.2	0.9	3.5
Winding inductance	L_D	[mH]	13.8	56	14.0	54.0
Electric time constant	t_{el}	[ms]	8.9	9	15.5	15.4
Moment of inertia (without brake)	J_{motore}	[kg \times m ²]	1.030×10^{-4}		2.88×10^{-4}	
Moment of inertia (with brake)	$J_{motore BR}$	[kg \times m ²]	1.160×10^{-4}		3.34×10^{-4}	
Rated braking torque	T_{BR}	[Nm]	6.5		14	
Brake supply voltage	U_{BR}	[V]	24 V dc		24 V dc	
Brake power	P_{BR}	[W]	23.8 ^{+ 5 %}		35.2 ^{+ 5 %}	
Brake engagement delay time	t_{BR}	[ms]	45 ^{- 10 %}		50 ^{- 10 %}	
Brake disengagement delay time	t_{-BR}	[ms]	10		15	
Permissible radial load on motor shaft	F_R	[N]	400		500	
Permissible axial load on motor shaft	F_N	[N]	130		150	
Mass without brake / mass with brake	m	[kg]	3.3 / 5.0		5.2 / 7.4	

11.3 Technical data

SA 6				Servoactuator size		
BM 102 L6 - 30		BM 102 L8 - 30		Servomotor size		
230 V ac	400 V ac	230 V ac	400 V ac	[M]	U_{nom}	Drive rated voltage
7.3		9.0		[Nm]	$T_{0,100K}$	Stall torque
6.4		6.7		[Nm]	$T_{nom,100K}$	Continuous rated torque
22.0		30.0		[Nm]	T_p	Peak torque
3000		3000		[rpm]	n_{nom}	Rated speed
4000		4000		[rpm]	n_{max}	Max. speed
6		8				Number of poles
9.8	6.1	11.5	5.8	[A]	$I_{0,100K}$	Stall current
35.5	22.0	47.0	25.5	[A]	I_p	Peak current
47.7	77.0	47.7	94.0	[V/1000 rpm]	k_E	Voltage constant
0.8	1.2	0.8	1.55	[Nm/A]	k_T	Torque constant
45		45		[min]	t_{th}	Thermal time constant
0.56	1.6	0.4	1.6	[Ω]	R_{ph}	Winding resistance
8.2	23.0	6.0	27.6	[mH]	L_D	Winding inductance
14.6	14.3	15.0	17.2	[ms]	t_{el}	Electric time constant
4.950×10^{-4}		4.950×10^{-4}		[kg × m ²]	J_{motore}	Moment of inertia (without brake)
5.410×10^{-4}		5.410×10^{-4}		[kg × m ²]	$J_{motore BR}$	Moment of inertia (with brake)
14		14		[Nm]	T_{BR}	Rated braking torque
24 V dc ^{+ 5 %} _{- 10 %}		24 V dc ^{+ 5 %} _{- 10 %}		[V]	U_{BR}	Brake supply voltage
35.2		35.2		[W]	P_{BR}	Brake power
50		50		[ms]	t_{BR}	Brake engagement delay time
15		15		[ms]	t_{BR}	Brake disengagement delay time
500		500		[N]	F_R	Permissible radial load on motor shaft
150		150		[N]	F_N	Permissible axial load on motor shaft
7.8 / 10.0		7.8 / 10.0		[kg]	m	Mass without brake / mass with brake

11.4 Motor feedback

E01: Optical incremental encoder

Supply voltage	[V dc]	5V ± 5%
Max. supply current	[mA]	200
Standard resolution	[pulses / turn]	2000
Electronics type	[-]	Line Driver
Max. frequency	[kHz]	200
Incremental signals (Line Driver)	[-]	A,A/ - B,B/ - Z,Z/
Switching signals (Line Driver)	[-]	HU,HU/ - HV,HV/ - HW,HW/
Operating temperature	[°C]	-20 ... +85
Max. speed	[rpm]	6000

R01: Resolver

Supply voltage	[V rms]	7 @ 10KHz
Transformation ratio	[-]	0.5 ± 5%
Number of pole-pairs	[-]	1
Electrical error	[-]	± 10' max
Operating temperature	[°C]	-55 ... +155
Max. speed	[rpm]	10000

A01: BISS absolute multiturn encoder

Supply voltage	[V dc]	5V
Current consumption	[mA]	150 ^{+ 10 %} _{- 5 %}
Single turn resolution	[-]	12-19 bit
Multiturn resolution	[-]	12 bit
Serial interface	[-]	BISS
Connection	[-]	Clock and Data RS422
Incremental signals	[-]	Sin Cos 1Vpp
Resolution	[pulses / turn]	2048
Operating temperature	[°C]	-40 ... +120
Max. speed	[rpm]	10000

11.5 Thermal protectors

01: Thermistore PTC

Suitable for fast overloads, no temperature monitoring

Signal type	[-]	Non linear resistance
Rated voltage	[V dc]	7,5
Max. voltage	[V dc]	30
Insulation voltage	[kV]	2,5
Switching temperature (standard)	[°C]	140
Resistance @ 135°C	[Ω]	≤ 550
Resistance @ 145°C	[Ω]	≥1330
Resistance @ 155°C	[Ω]	≥4000

02: Bimetallic thermal protectors PTO

Suitable for long time overloads, no temperature monitoring

Signal type	[-]	NC - normally closed
Switching temperature	[°C]	140
Reactivation temperature	[°C]	110 ± 15
Supply voltage	[V]	250
Rated current	[A]	2,5
Insulation current	[kV]	2

03: KTY84-130

Temperature monitoring

Temperature monitoring		YES
Signal type	[-]	Linear resistance
Continuous current	[mA]	2
Operating temperature	[°C]	-40 ... +300
Resistance @100°C, 2mA	[Ω]	min 970 max 1030
Resistance rate R100°C/R25°C	[-]	min 0.595 max 0.611
Resistance rate R250°C/R100°C		min 2.111 max 2.221

NOTE: ECO Series drives supplied with Linearmech servomotors support 02 (PTO) protection only.

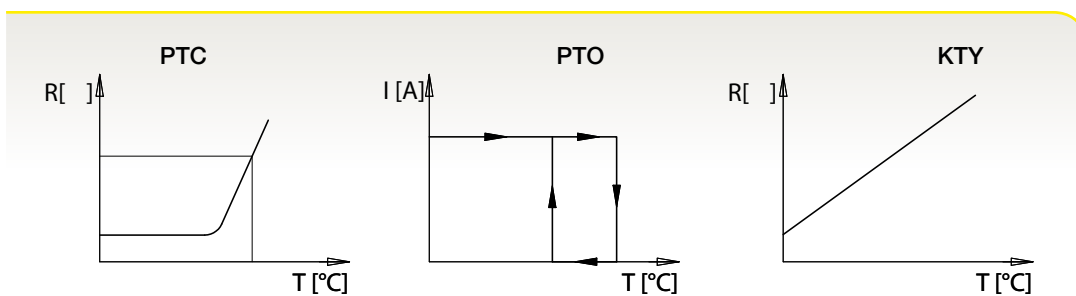

11.6 Motor connections

11.6.1 BM 45 / 63 CN - M17 Connectors

POWER M17 7-POLE	
Pin	Function
1	Phase U
2	Phase V
3	-
	PE
4	Brake +
5	Brake -
6	Phase W

SIGNAL M17 17-POLE			
Pin	E01: Incremental encoder	R01: Resolver	A01: BISS absolute encoder
1	CHB	Sin+	DATA
2	CHB/	Sin-	DATA/
3	Z	-	A+
4	HU	-	B+
5	HW	-	DC 5V
6	-	-	-
7	OV enc	R2	0V sensor
8	PT (optional)	PT (optional)	PT (optional)
9	PT (optional)	PT (optional)	PT (optional)
10	5 V enc	R1	5V sensor
11	CHA/	Cos-	CLOCK/
12	CHA	Cos+	CLOCK
13	Z/	-	A-
14	HU/	-	B-
15	HV/	-	-
16	HV	-	-
17	HW/	-	0V Un

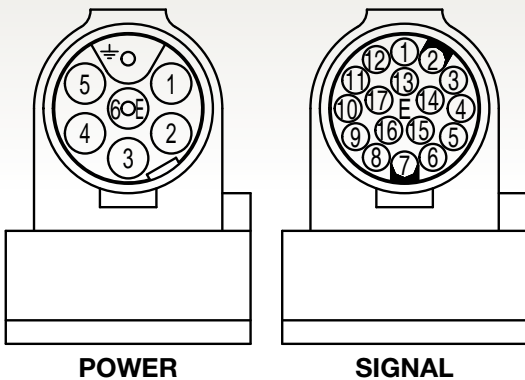

Connectors orientation

Connectors may rotate to be properly oriented.
The drawing shows the angular range of orientation.

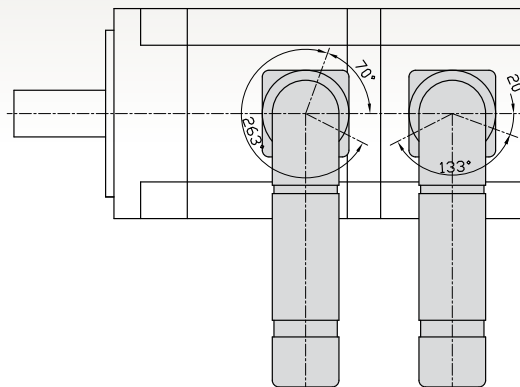

11.6 Motor connections

11.6.2 BM 45 / 63 CV - Cables, no connectors

POWER		SIGNAL			
Wire color	Function	E01: Incremental encoder		R01: Resolver	
Wire color	Function	Wire color	Function	Wire color	Function
White	Phase U	Green	CHB	Yellow	Sin+
Black	Phase V	Green / Black	CHB/	Blue	Sin-
Yellow - Green		Yellow	Z	-	-
Red 0,5 mm ²	Brake +	Brown	HU	-	-
Black 0,5 mm ²	Brake -	White	HW	-	-
Red	Phase W	-	-	-	-
		Black	0V ENC	Yellow/White or Black/White	R2
		-	-	-	-
		-	-	-	-
		Red	+5V ENC	White/Red	R1
		Blue	CHA/	Black	Cos-
		Blue / Black	CHA	Red	Cos+
		Yellow / Black	Z/	-	-
		Brown / Black	HU/	-	-
		Grey / Black	HV/	-	-
		Grey	HV	-	-
		White / Black	HW/	-	-

NOTE: Connections with cables (no connectors) are only available with 24/48 V dc supply.

11.6 Motor connections

11.6.3 BM 82 / 102 CN - M23 Connectors

POWER M23 6-POLE	
Pin	Function
1	Phase U
2	Phase V
	PE
4	Brake +
5	Brake -
6	Phase W
6	Phase W

SIGNAL M23 17-POLE			
Pin	E01: Incremental encoder	R01: Resolver	A01: BISS absolute encoder
1	CHB	Sin+	DATA
2	CHB/	Sin-	DATA/
3	Z	-	A+
4	HU	-	B+
5	HW	-	DC5V / 7-30V
6	-	-	-
7	OV enc	R2	OV sensor
8	PT (optional)	PT (optional)	PT (optional)
9	PT (optional)	PT (optional)	PT (optional)
10	5 V enc	R1	5V sensor
11	CHA/	Cos-	CLOCK/
12	CHA	Cos+	CLOCK
13	Z/	-	A-
14	HU/	-	B-
15	HV/	-	-
16	HV	-	-
17	HW/	-	OV Un

Connectors orientation

Connectors may rotate to be properly oriented.
The drawing shows the angular range of orientation.

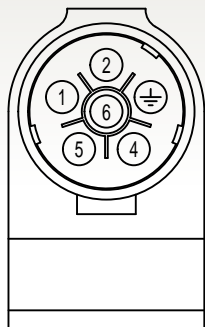

POWER

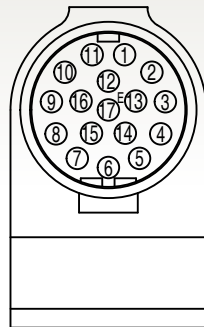

SIGNAL

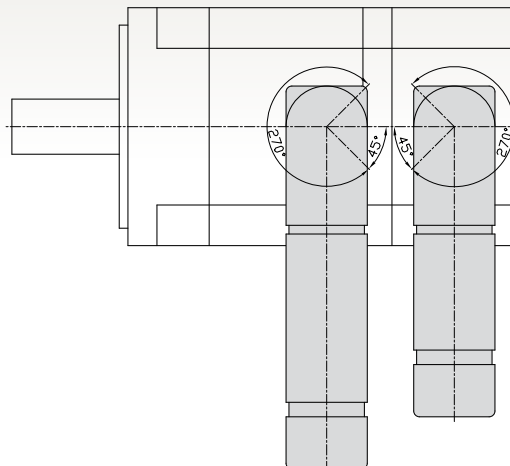

LINEARMECH product range also includes a complete Series of drives, specifically engineered and developed for Linearmech brushless servomotors BM Series and linear servoactuators SA Series. Linearmech can provide you a **full package solution** with the advantage of having a sole responsible partner from the initial phase of product selection up to the start-up operations of your applications.



12.1 General features

Drives ECO Series by LINEARMECH are full digital products, optimized to control sinusoidal motors.

The implemented control (**Field Oriented Control**) allows high accuracy in motion control, together with Torque, Speed and Positioning control.

The **integrated mechatronic functions** also allows to manage even complex movements with simple digital / serial inputs.

Drives ECO Series operating modes:

TORQUE CONTROL

- analogic reference (0 ... 10) V
- access to the internal drive registers (field networks)

SPEED CONTROL

- analogic reference $\pm 10V$
- access to the internal drive registers (field networks)

POSITIONING CONTROL

- SAP (Stand Alone Positioning)
- MSQ (Multi Sequencer)
- Electrical Axis
- Field networks
 - Ethercat (Coe)
 - CANopen (DS402)
 - RS 422/485 (SNET @ 19200 Baud)
 - Modbus RTU (@ 19200 Baud)

The RS 422 serial port is available as standard. It enables the connection of all drives to a PC through a **serial line**.

The **“DRIVEWATCHER” application software** allows you to manage settings and debug functions. The software allows you to analyze all the data both coming from the drive unit and from the complete dynamic system, load and actuators parameters included.

Using the program utility, it is possible to save and control (graphics and diagrams allow you to have an immediate visual response) all the relevant measurements during the operations, such as speed, power, voltage. This to get the real evaluation of the required torque and finally to reach the better optimization of the system as a whole.

Following sections refer to the general information of each single operating mode; for more information, please refer to the specific manuals.

12.2 SAP (Stand Alone Positioning)

The SAP integrated mechatronic function allows to obtain a completely independent positioning, without any PLCs or PCs.

Through the selection of digital inputs, it is possible to recall TARGET positions, previously set inside the drive with DRIVE WATCHER software tool.

The system allows the following movements:

- ZERO SETTING, positioning adjustment related to the input of a sensor
- Movement with an ABSOLUTE positioning related to a reference position
- Movement with a RELATIVE positioning related to the current position

SAP operating mode

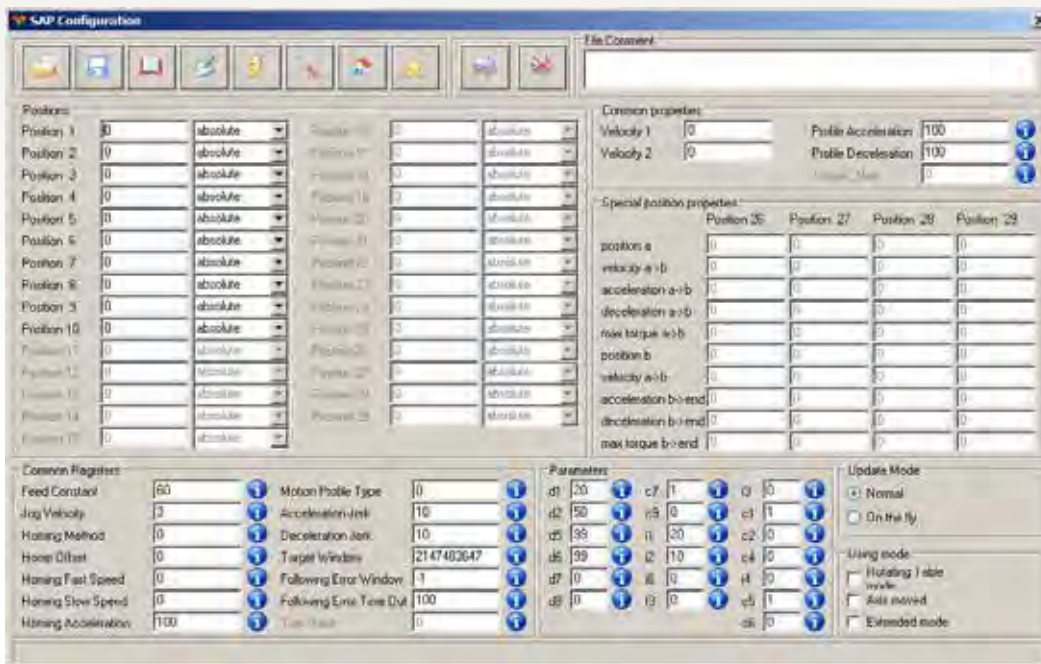
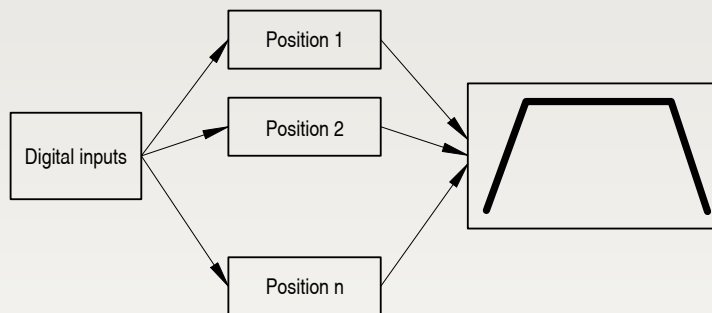

SAP Control panel

12.3 MSQ (Motion Sequencer)

The MSQ integrated mechatronic function allows connecting a sequence of independent movements to manage even sophisticated applications, without any PLCs or PCs.

The system allows the following movements:

- ZERO SETTING, positioning adjustment related to the input of a sensor
- Movement with an ABSOLUTE positioning related to a reference position
- Movement with a RELATIVE positioning related to the current position
- Movement index
- Movement positioning after counting
- Movement positioning by external signal

MSQ operating mode

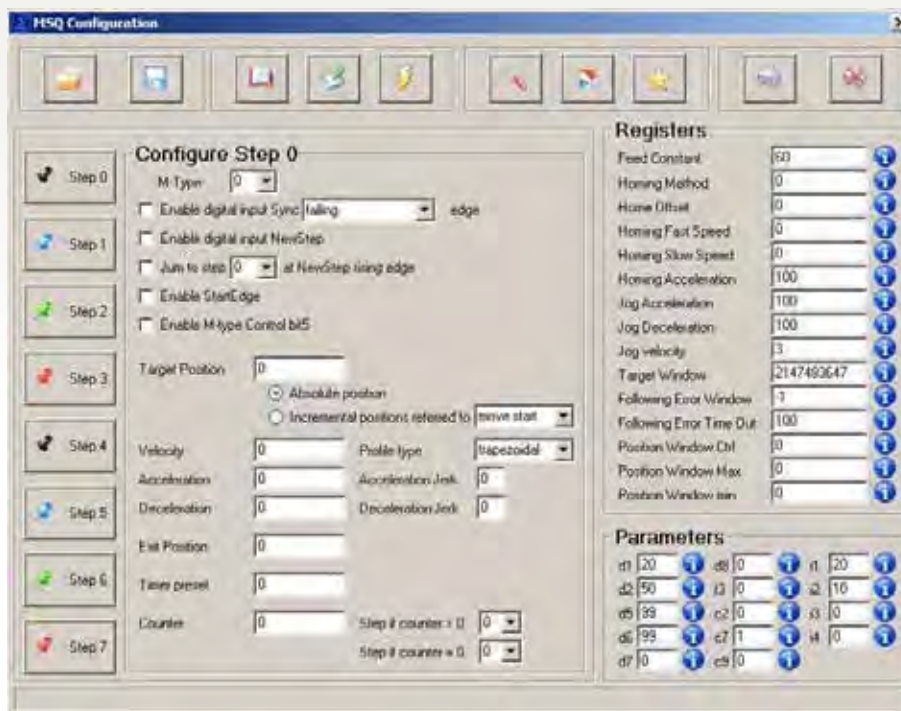
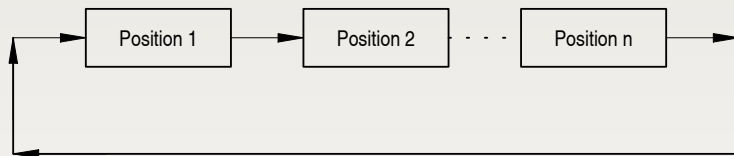

MSQ Control panel

12.4 Electrical axis

The Electrical Axis integrated mechatronic function allows relating the movement of a servomotor (SLAVE) to the action of another motor (MASTER encoder). Possibility to set a given transmission ratio through a parameter (electric cam).

ELECTRICAL AXIS operating mode

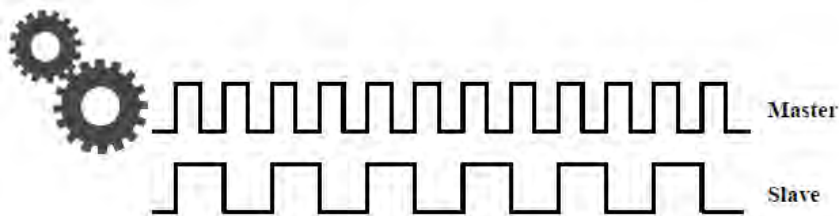

12.5 Field Networks

Thanks to the fieldbus networks, it is possible to manage the drive by exchanging the information with a MASTER system in serial mode.

They offer great flexibility thanks to the possibility of modifying parameters, sending a speed or position setpoint or adding specific mechatronic functions.

A reduced need for wiring is possible by connecting several drives to the same serial line. Field networks differ from each other in communication speed, numbers of functions that can be managed and reference standards.

ETHERCAT

According to the new standards of industrial applications, the Ethercat fieldbus is now taking the lead.

High-speed communication bus, able to get real-time performances of drives. Specifically useful in case of application when many axes are involved with high dynamic and performance needs.

Ethercat is an industrial communication protocol with high performances, which extend the IEEE 802.3 Ethernet standard, allowing data transfer with predictable timing and an extremely precise synchronization. All data are transferred in the standard Ethernet frame without modifying the basic structure.

For this reason the connection of the drive to an Ethercat network is made by a RJ45 connector, whose wiring respects Ethernet / IEEE 802.3 10Base-T, 100Base-TX and 1000Base standards.

The Ethercat protocol applied on the Linearmech ECO Series Drives is Ethercat (CoE), this means a CANopen over EtherCAT.

CANopen

CANopen is a standard application for automation systems based on CAN (Controller Area Network) offering the following performance features:

- Transmission of critical data process according to the producer / consumer principle
- Standard description of the device (data, parameters, functions, programs) in the form of the so-called "object dictionary"
- Standard services for device monitoring, error signal (emergency messages) and network coordination ("network management")

The implemented protocol refers to the CiA CANopen - Device Profile Drives and Motion Control - DSP 402 v1.1.

RS 422/485 - MODBUS RTU

These networks are very flexible but not really fast. Mostly used for changing parameters, positioning registers and running integrated mechatronic functions.

12.6 Models and functions

Model	ELECTRICAL CHARACTERISTICS			MECHATRONIC FUNCTIONS			
	Supply voltage [V]	Rated current [A] (RMS value)	Peak current [A] (RMS value)	Analogic	SAP MSQ	Electrical axis	Field networks
MICROECO 10-20	24 ... 48 V dc	10	20	•	•	-	• (NO Ethercat)
MINIECO 3-6	230 V ac	3	6	•	-	-	• (NO Ethercat)
MINIECO PLUS 4-8		4	8				
ECO 2D 4-10	230 V ac	4	10	•	•	•	• (Ethercat optional)
ECO 2D 6-15		6	15				
ECO 4D 4-10	400 V ac	4	10	•	•	•	• (Ethercat optional)
ECO 4D 5-13		5	13				
ECO 4D 10-20		10	20				

NOTE: Ethercat fieldbus network only available for ECO2D and ECO4D Drives Series.

12.7 Available trasducers

Model	ELECTRICAL CHARACTERISTICS			SUPPORTED FEEDBACKS		
	Supply voltage [V]	Rated current [A] (RMS value)	Peak current [A] (RMS value)	Incremental encoder 5 V LD with switching sensors E01	Resolver R01	Absolute multturn encoder with BISS protocol A01
MICROECO 10-20	24 ... 48 V dc	10	20	•	-	-
MINIECO 3-6	230 V ac	3	6	•	-	-
MINIECO PLUS 4-8		4	8			
ECO 2D 4-10	230 V ac	4	10	•	optional	optional
ECO 2D 6-15		6	15			
ECO 4D 4-10	400 V ac	4	10	•	optional	optional
ECO 4D 5-13		5	13			
ECO 4D 10-20		10	20			

NOTE: in case of use of a RESOLVER or an ABSOLUTE ENCODER, please contact LINEARMECH technical support for assistance in Linearmech ECO Series Drive selection and configuration.

12.8 Recommended Servomotors - Drives matching

The table below shows the recommended matching between **Linearmech Servomotors BM Series** and **Drives ECO Series** with the related performances (standard motor wiring rated speed 3000 rpm).

WARNING: the performance diagrams shows in Chapter 4.4 (pages 26-35) and Chapter 5.4 (pages 42-57) refers to the maximum motor performances. Possible degrading in performances must be considered depending on the selected drive, as specified in the table below.

			BM 45 L	BM 63 S	BM 63 L	
MINIECO 10-20	24 V dc	$T_{0, 100K}$ [Nm]	0.35	0.44	0.38	
		$T_{nom, 100K}$ [Nm]	0.32	0.34	0.35	
		T_p [Nm]	0.86	0.82	0.76	
	48 V dc	$T_{0, 100K}$ [Nm]	0.35	0.70	0.89	
		$T_{nom, 100K}$ [Nm]	0.32	0.60	0.84	
		T_p [Nm]	1.05	1.65	1.67	
MINIECO 3-6	230 V ac	$T_{0, 100K}$ [Nm]	0.35	0.70	1.35	
		$T_{nom, 100K}$ [Nm]	0.32	0.60	1.30	
		T_p [Nm]	1.05	2.10	3.80	
MINIECO PLUS 4-8		$T_{0, 100K}$ [Nm]	0.35	0.70	1.35	
		$T_{nom, 100K}$ [Nm]	0.32	0.60	1.30	
		T_p [Nm]	1.05	2.10	4.20	
ECO 2D 4-10	230 V ac	$T_{0, 100K}$ [Nm]	0.35	0.70	1.35	
		$T_{nom, 100K}$ [Nm]	0.32	0.60	1.30	
		T_p [Nm]	1.05	2.10	4.20	
ECO 2D 6-15		$T_{0, 100K}$ [Nm]				
		$T_{nom, 100K}$ [Nm]				
		T_p [Nm]				
ECO 4D 4-10		400 V ac	$T_{0, 100K}$ [Nm]			
			$T_{nom, 100K}$ [Nm]			
			T_p [Nm]			
ECO 4D 5-13	$T_{0, 100K}$ [Nm]					
	$T_{nom, 100K}$ [Nm]					
	T_p [Nm]					
ECO 4D 10-20	$T_{0, 100K}$ [Nm]					
	$T_{nom, 100K}$ [Nm]					
	T_p [Nm]					

12.8 Recommended Servomotors - Drives matching

The table below shows the recommended matching between **Linearmech Servomotors BM Series** and **Drives ECO Series** with the related performances (standard motor wiring rated speed 3000 rpm).

WARNING: the performance diagrams shows in Chapter 4.4 (pages 26-35) and Chapter 5.4 (pages 42-57) refers to the maximum motor performances. Possible degrading in performances must be considered depending on the selected drive, as specified in the table below.

BM 82 L	BM 102 S	BM 102 L6	BM 102 L8		
				[Nm] $T_{0, 100K}$	MINIECO 10-20
				[Nm] $T_{nom, 100K}$	
				[Nm] T_p	
				[Nm] $T_{0, 100K}$	
				[Nm] $T_{nom, 100K}$	
				[Nm] T_p	
1.90				[Nm] $T_{0, 100K}$	MINIECO 3-6
1.52				[Nm] $T_{nom, 100K}$	
3.65				[Nm] T_p	
2.50				[Nm] $T_{0, 100K}$	MINIECO PLUS 4-8
2.16				[Nm] $T_{nom, 100K}$	
4.80				[Nm] T_p	
2.50	3.22			[Nm] $T_{0, 100K}$	ECO 2D 4-10
2.16	2.10			[Nm] $T_{nom, 100K}$	
6.10	6.72			[Nm] T_p	
2.90	4.82	4.50	4.70	[Nm] $T_{0, 100K}$	ECO 2D 6-15
2.50	3.70	3.90	2.50	[Nm] $T_{nom, 100K}$	
9.00	10.10	9.30	11.80	[Nm] T_p	
2.90	5.20	4.80	6.20	[Nm] $T_{0, 100K}$	ECO 4D 4-10
2.50	4.10	3.90	3.90	[Nm] $T_{nom, 100K}$	
9.00	10.70	10.00	13.80	[Nm] T_p	
	5.20	6.00	7.70	[Nm] $T_{0, 100K}$	ECO 4D 5-13
	4.10	5.10	5.45	[Nm] $T_{nom, 100K}$	
	13.90	13.00	17.50	[Nm] T_p	
	5.20	7.30	9.00	[Nm] $T_{0, 100K}$	ECO 4D 10-20
	4.10	6.40	6.70	[Nm] $T_{nom, 100K}$	
	15.00	20.00	24.30	[Nm] T_p	

12.9 Dimensions

MICROECO

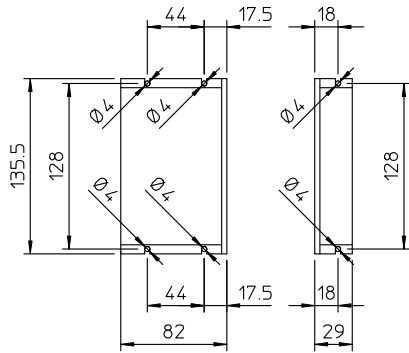

MINIECO, MINIECO Plus

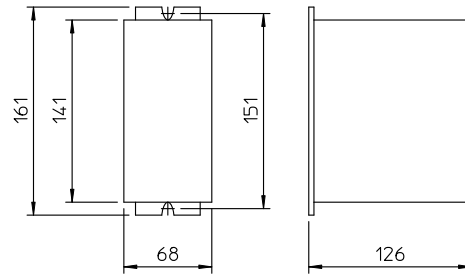

ECO2D 4-10 A 230 V, ECO2D 6-15 A 230 V, ECO4D 4-10 A 400 V, ECO4D 5-13 A 400 V

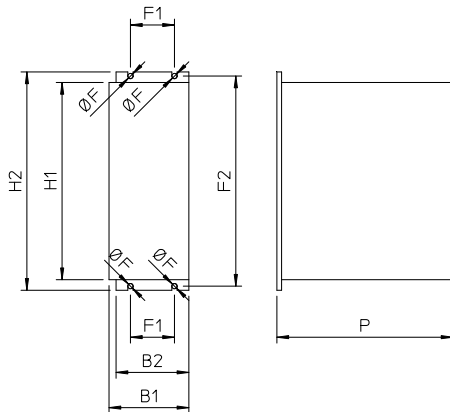



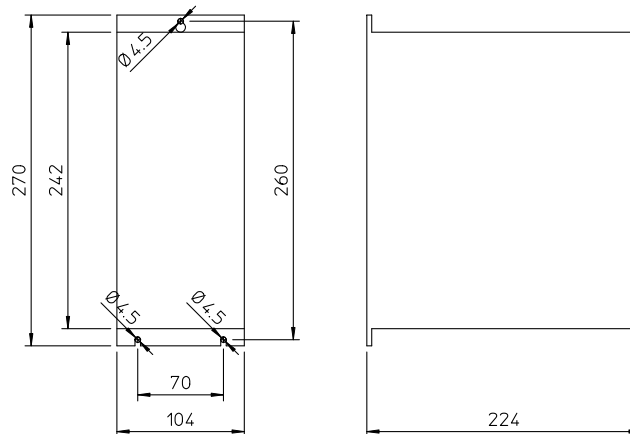

	B1	B2	Ø F	F1	F2	H1	H2	P
ECO2D 4-10 A 230 V	68	62	4.5	37.5	179	168	186	150
ECO2D 6-15 A 230 V	82							
ECO4D 4-10 A 400 V	73	67	4.5	42.5	220	210	227	190
ECO4D 5-13 A 400 V	87							

ECO4D 10-20 A 400 V





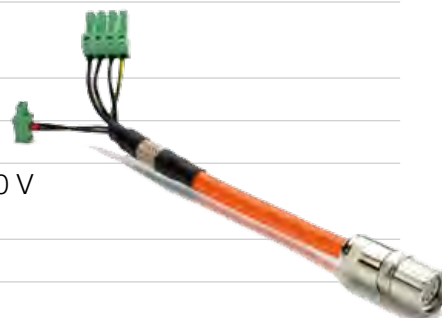

On request, wirings can be supplied with power and signal connectors from the servomotor to the drive.
The standard cable length is 5 m.

13.1 Power supply cable

Outer jacket material:	PVC - Class 43 for UL 1581 and CSA 22.2 n°210 Colour: orange
Operating temperature:	for fixed wiring, without external mechanical stress: (- 40 ... + 80)°C for mobile laying cables: (- 10 ... + 80)°C
Minimum bending radius:	for fixed wiring: 4 × cable diameter for mobile laying cables: 7.5 × cable diameter
Max. shifting speed for trailing cables:	3 m/s
Max. acceleration/deceleration:	10 m/s ²
Fatigue life for trailing cables:	(3 ... 6) million movements
Operating voltage:	STYLE 2464: 300 V (UL) - U ₀ /U 450/750 V STYLE 2570: 1000 V (UL)
Reference standards:	CSA 22.2 n°210, UL 1581
Approvals:	UL recognized / CSA ( or )  AWM STYLE 2464 80°C 300 V - CSA  AWM STYLE 2570 80°C 1000 V - CSA
Fire performance:	self-extinguishing VW-1 (UL); FT1 (CSA); IEC 60332-1, CEI 20-35 (EU)
Industrial oils resistance:	ASTM n°2, IRM 902, IEC 60811-2-1



13.2 Signal cable

Outer jacket material:	PVC - Class 43 for UL 1581 and CSA 22.2 n°210 Colour: green
Operating temperature:	for fixed wiring, without external mechanical stress: (- 40 ... + 80)°C for mobile laying cables: (- 10 ... + 80)°C
Minimum bending radius:	for fixed wiring: 4 × cable diameter for mobile laying cables: 7.5 × cable diameter
Max. shifting speed for trailing cables:	3 m/s
Max. acceleration/deceleration:	10 m/s ²
Fatigue life for trailing cables:	(3 ... 6) million movements
Operating voltage:	30 V - 300 V (UL)
Reference standards:	CSA 22.2 n°210, UL 1581
Approvals:	UL recognized / CSA ( or )  AWM STYLE 2464 80°C 300 V - CSA  AWM STYLE 2570 80°C 1000 V - CSA
Fire performance:	self-extinguishing VW-1 (UL); FT1 (CSA); IEC 60332-1, CEI 20-35 (EU)
Industrial oils resistance:	ASTM n°2, IRM 902, IEC 60811-2-1



14.1 SA Series Actuator

SA 3	BS2	C200	Vers.1	FLO° TM	FPH
1	2	3	4	5	6

1	Actuator size	page 10-11
2	Ball screw	page 10-11
3	Stroke	page 12
4	Input shaft version	page 12
	Vers.1 = cylindrical input shaft (standard)	
	Vers.5 = interface for fitting of motors/servomotors supplied by the customer	
5	Accessories and relevant mounting position	page 24-25
6	Stroke end switches	page 84-85

14.2 SA IL Series Servoactuator

SA 3 IL	BS2	C200	MN	PBS	FPH
1	2	3	4	5	6

1	Actuator size	page 20-21
2	Ball screw	page 20-21
3	Stroke	page 23
4	Servomotor mounting position	page 22
5	Accessories and relevant mounting position	page 24-25
6	Stroke end switches	page 84-85

14.3 SA PD Series Servoactuator

SA 3 PD	RV	BS2	C200	MN	PW	TS CM RPT0°	FPH
1	2	3	4	5	6	7	8

1	Actuator size	page 36-37
2	Ratio	page 36-37
3	Ball screw	page 36-37
4	Stroke	page 39
5	Servomotor mounting position	page 38
6	Stroke end switch slot position	page 38
7	Accessories and relevant mounting position	page 40-41
8	Stroke end switches	page 84-85

14.4 BM Series Servomotor

BM 45 L	-	30	24	E01	CV	01	L
1	2	3	4	5	6	7	8

1	Servomotor size	page 88-91
2	Brake	page 88-91
	- = without brake	
	B = with holding brake 24V dc	
3	Rated speed	
	30 = 3000 rpm (standard)	
	40 = 4000 rpm ⁽¹⁾	
	50 = 5000 rpm ⁽¹⁾	
	60 = 6000 rpm ⁽²⁾	
4	Drive supply voltage	page 102-103
	24 = 24 V dc	
	48 = 48 V dc	
	230 = 230 V ac - 1-phase	
	400 = 400 V ac - 3-phase	
5	Motor feedback	page 92
	E01: optical encoder, LINE-DRIVER, 2000 ppr (standard)	
	R01: resolver, 1 pole pairs 7 V rms, 10 kHz (optional)	
	A01: BISS absolute multiturn encoder (option available starting from size BM 63)	
	- = without device	
6	Electrical connections	page 94-96
	CV = power and signal cable, 0.5 m long, no connectors	
	CN = double 90° connector	
7	Thermal protection	page 93
	- = without device	
	01 = PTC ⁽³⁾	
	02 = PTO	
	03 = KTY 84-130 ⁽³⁾	
8	Output shaft version	
	C = cylindrical shaft	
	L = shaft with key	

(1) - available only for BM 45 and BM 63 sizes - Contact LINEARMECH support for more information

(2) - available only for BM 45 size - Contact LINEARMECH support for more information

(3) - not supported by ECO series drives supplied by Linearmech

14.5 ECO Series Drive

ECO 2D 4-10	230 V	SAP + MSQ	E01	-
1	2	3	4	5
1 Drive model				page 101
2 Supply voltage				page 101
3 Positioner				page 101
4 Motor feedback				page 92
5 Ethercat communication bus				page 101

Linearmech ECO Series Drives complete options and coding:

Model	Supply voltage	Positioner	Feedback	Ethercat
MICROECO 10-20	24 ... 48 V dc	SAP + MSQ	E01	-
MINIECO 3-6	230 V ac	SAP + MSQ	E01	-
MINIECO PLUS 4-8	230 V ac	-	E01	-
			A01	-
ECO 2D 4-10	230 V ac	SAP + MSQ	E01	- Ethercat
			R01	- Ethercat
			A01	- Ethercat
ECO 2D 6-15	230 V ac	SAP + MSQ	E01	- Ethercat
			R01	- Ethercat
			A01	- Ethercat
ECO 4D 4-10	400 V ac	SAP + MSQ	E01	- Ethercat
			R01	- Ethercat
			A01	- Ethercat
ECO 4D 5-13	400 V ac	SAP + MSQ	E01	- Ethercat
			R01	- Ethercat
			A01	- Ethercat
ECO 4D 10-20	400 V ac	SAP + MSQ	E01	- Ethercat
			R01	- Ethercat
			A01	- Ethercat

14.6.1 Connecting cables - Signal

CS	R01	M17	05	1
1	2	3	4	5
1	Cable type			page 105
CS = signal cable				
CP = power supply cable				
2	Motor feedback			page 92
E01: optical encoder, LINE-DRIVER, 2000 ppr				
R01: resolver, 1 polar pair, 7 V rms, 10 kHz				
A01: BISS absolute multiturn encoder				
3	Motor side connectors			page 94-96
M17 = M17 17-pole connector				
M23 = M23 17-pole connector				
4	Length			
05 = 5 meters				
10 = 10 meters				
15 = 15 meters				
5	Drive side connectors			
1 = 26-pole HD type connector (for MINIECO-ECO2D-ECO4D drives)				
2 = No connectors (for MICROECO drives)				

14.6.2 Connecting cables - Power supply

CP	M17	10	
1	2	3	
1	Cable type		page 105
CS = signal cable			
CP = power supply cable			
2	Motor side connectors		page 94-96
M17 = M17 7-pole connector			
M23 = M23 6-pole connector			
3	Length		
05 = 5 meters			
10 = 10 meters			
15 = 15 meters			

A. Terms and Definitions

Term	Symbol	Unit of measure	Definition
MOTOR			
Continuous rated torque	$T_{nom, 100K}$	Nm	Torque supplied by the motor for an unlimited period of time, at nominal speed (in thermal balance condition), without exceeding the thermal limits of the relevant insulation class. This condition is defined during test run at conditions described in appendix B.
Stall torque	$T_{0, 100K}$	Nm	Torque supplied by the motor for an unlimited period of time, with blocked rotor (in thermal balance condition), without exceeding the thermal limits of the relevant insulation class. This condition is defined during test run at a rotation speed closed to 0 rpm, at conditions described in appendix B.
Peak torque	T_p	Nm	Torque generated at max. current (peak). The max. torque is possible for short periods of time to have a dynamic system behaviour (abrupt variations of the operating condition). Exceeding this value causes the irreversible demagnetization of the rotor magnetic group.
S3 rated torque	$T_{30\%}$	Nm	Torque supplied by the motor in S3 usage limits (30% on 10 min) at nominal speed, without exceeding the thermal limits of the relevant insulation class.
Rated speed	n_{nom}	rpm	Speed performed by the motor for an unlimited period of time, without exceeding the thermal limits of the relevant insulation class, with torque as defined in the TORQUE - SPEED curve shown in the motor specific diagram.
Max. speed	n_{max}	rpm	Max. permissible rotating speed. It depends on centrifugal force of rotating masses, rotor balance grade and bearings.
Stall current	$I_{0, 100K}$	A	Current (RMS value) phase - phase supplied to the motor in order to generate the torque in conditions of blocked rotor (stall).
Peak current	I_p	A	Current (RMS value) phase - phase supplied to the motor in order to generate the max. torque (peak). This current is limited by the motor magnetic circuit: exceeding this value even for a short time causes the irreversible demagnetization of the magnets.
Voltage constant	k_E	V/1000 rpm	Voltage (RMS value) phase - phase produced by operating motor at 1 000 rpm, at 20°C ambient temperature, with average windings temperature increment of 20 K.
Torque constant	k_T	Nm/A	Ratio between torque with blocked rotor and current with blocked rotor ($T_{0, 100K} / I_{0, 100K}$), with windings temperature increment of 100 K (insulation class F).
Thermal time constant	t_{th}	min	Time necessary to heat the cold motor up to a temperature increase of $0.63 \times 100 K$, with load $I_{0, 100K}$.
Winding resistance	R_{ph}	Ω	Electric resistance of phase - phase windings connected in Y circuit, at 20°C ambient temperature.
Winding inductance	L_D	mH	Inductance of phase - phase windings connected in Y circuit.
Electric time constant	t_{el}	ms	Ratio between winding inductance and winding resistance (L_D / R_{ph}).
Moment of inertia (without brake)	J_{motore}	$kg \times m^2$	Moment of inertia of motor rotating elements.
Moment of inertia (with brake)	$J_{motore BR}$	$kg \times m^2$	Moment of inertia of motor and brake rotating elements.
Permissible radial load on motor shaft	F_R	N	Constant load radially applied on the centre of the motor shaft, at 3 000 rpm for nominal bearing service life of 10 000 h.
Permissible axial load on motor shaft	F_N	N	Constant load axially applied on the motor shaft, at 3 000 rpm for nominal bearing service life of 10 000 h.
BRAKE			
Supply voltage	U_{BR}	V	Voltage supplied to the brake excitation coil to release the brake.
Brake power	P_{BR}	W	Power consumption of the brake excitation coil.
Rated braking torque	T_{BR}	Nm	Holding braking torque (it cannot be used to stop the motor).
Brake disengagement delay time	t_{-BR}	ms	Reacting time from the moment the rated power supply voltage is applied until the brake is completely disengaged.
Brake engagement delay time	t_{BR}	ms	Reacting time from the moment the brake power supply is interrupted until the rated braking torque T_{BR} is reached.

B. Test conditions

All electrical and mechanical performances of **Linearmech BM Series servomotors** are obtained during test run, where the servomotor has been fixed horizontally, supported by an aluminium plate thermally insulated from the base of the test bench, and coupled by dynamometer to the brake.

The dimensions of aluminium plates used is related to the servomotor size:

- BM 45, BM 63, BM 82: 250×250×6 mm
- BM 102: 350×350×20 mm

During thermal test for the definition of stall torque ($T_{0, 100K}$) and continuous rated torque ($T_{nom, 100K}$) the motor, in thermal balance conditions, run to a windings temperature increment of 100 K, without exceeding temperature limits related to the F insulation class.

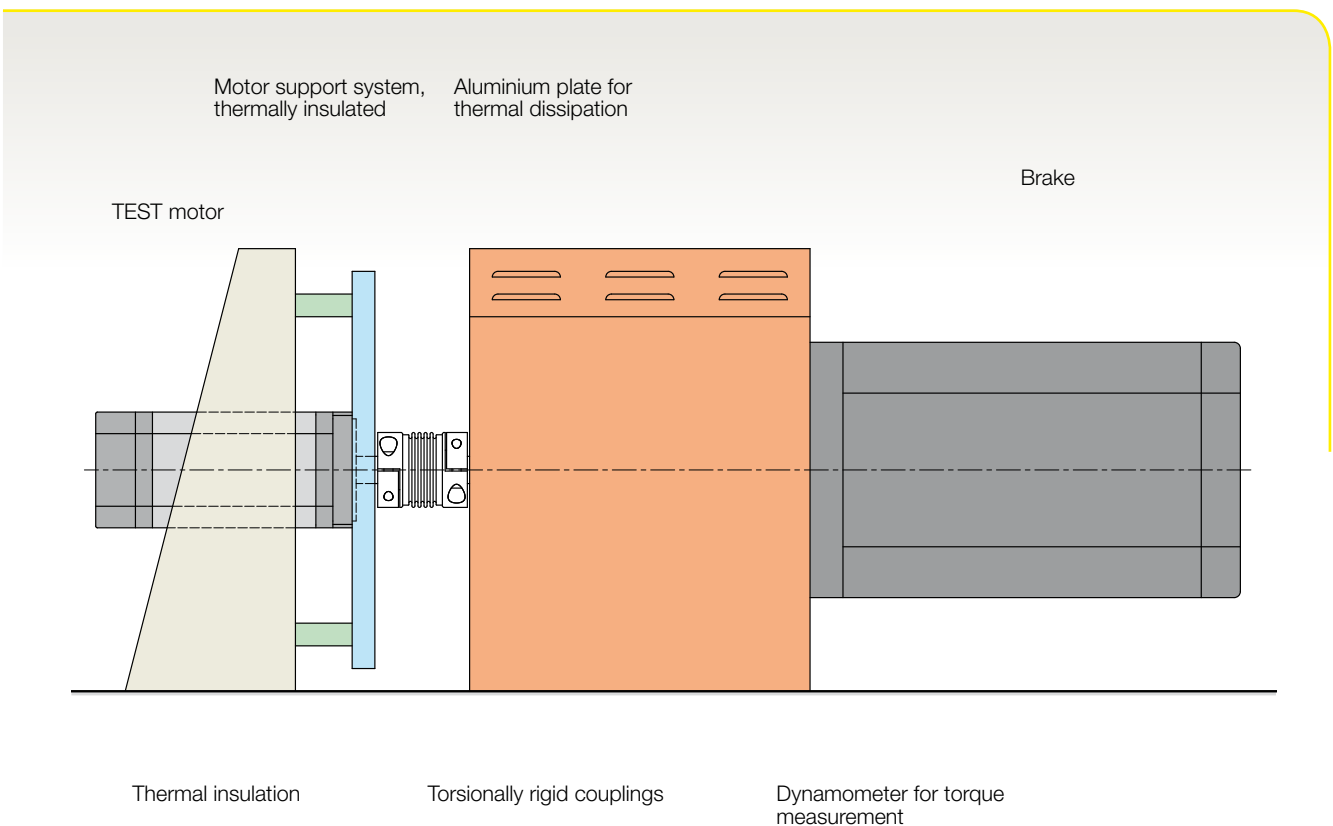

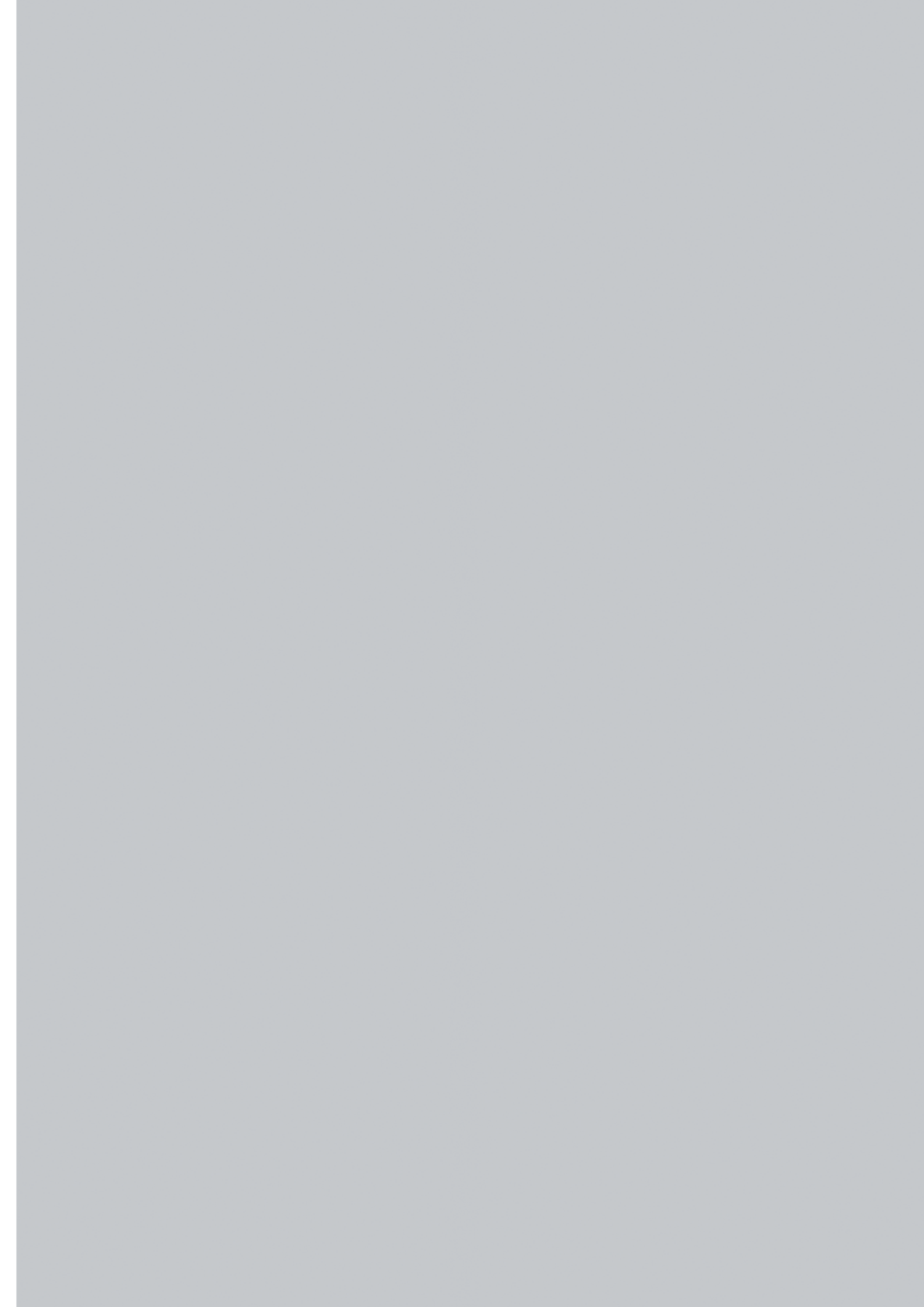

In this catalogue you will find:

Linear Actuators SA Series

Input shaft version, easy to fit customers servomotors
7 sizes available

Servo Linear Actuators SA IL Series

fitting Linearmech brushless servomotors In Line Design
7 sizes available

Servo Linear Actuators SA PD Series

fitting Linearmech brushless servomotors Parallel Design
7 sizes available

Brushless Servomotors BM Series

High efficiency and performances
Advanced technology, compact design
7 sizes available
Nominal torque up to 10 Nm

Eco Series Drives

Engineered focusing on linear performances for Automation Industry
Fully integrated in Linearmech Linear Servo-Systems:
Actuators + Brushless Servomotors + Drives



Linearmech S.r.l.

Via Caduti di Sabbiuno, 3 - 40011 Anzola dell'Emilia (Bologna) - ITALY
Tel. +39.051.6504311 - Fax +39.051.6504313 - info@linearmech.it

www.linearmech.it